

# **HRXD9, HRXD16**

**9-, 16-Channel Models  
Digital Video Recorder**

## **User Guide**

## Revisions

<b>Issue</b>	<b>Date</b>	<b>Revisions</b>
1.00	12/06	New document.
2.00	10/07	Manual updated for the latest software release.
3.00	11/07	Minor changes and corrections.
A	01/08	Add DVD-RW to the manual (specifications and other places).
B	02/08	Added a Caution to the "Connecting the Power Cord" section of the Installation chapter.

---

## FCC Compliance Statement

---

**INFORMATION TO THE USER:** This equipment has been tested and found to comply with the limits for a Class A digital device, pursuant to part 15 of the FCC rules. These limits are designed to provide reasonable protection against harmful interference when the equipment is operated in a commercial environment. This equipment generates, uses, and can radiate radio frequency energy and, if not installed and used in accordance with the instruction manual, may cause harmful interference to radio communications. Operation of this equipment in a residential area is likely to cause harmful interference in which case the user will be required to correct the interference at his own expense.

**CAUTION:** Changes or modifications not expressly approved by the party responsible for compliance could void the user's authority to operate the equipment.

This Class A digital apparatus complies with Canadian ICES-003.

Cet appareil numérique de la Classe A est conforme à la norme NMB-003 du Canada.

---

## Explanation of Graphical Symbols



---



This symbol alerts the user to the presence of uninsulated "dangerous voltage" within the product's enclosure that may be of sufficient magnitude to constitute a risk of electric shock.



This symbol alerts the user to the presence of important operating and maintenance (servicing) instructions in the literature accompanying the appliance.

	<b>WARNING</b> RISK OF ELECTRIC SHOCK DO NOT OPEN	
<b>WARNING:</b> TO REDUCE THE RISK OF ELECTRIC SHOCK, DO NOT REMOVE COVER (OR BACK). NO USER-SERVICEABLE PARTS INSIDE. REFER SERVICING TO QUALIFIED SERVICE PERSONNEL.		

---

# Compliance

---

## WEEE (Waste Electrical and Electronic Equipment)

**Correct Disposal of this Product** (Applicable in the European Union and other European countries with separate collection systems)



This marking shown on the product or its literature, indicates that it should not be disposed with other household wastes at the end of its working life. To prevent possible harm to the environment or human health from uncontrolled waste disposal, please separate this from other types of wastes and recycle it responsibly to promote the sustainable reuse of material resources.

Household users should contact either the retailer where they purchased this product, or their local government office, for details of where and how they can take this item for environmentally safe recycling.

Business users should contact their supplier and check the terms and conditions of the purchase contract. This product should not be mixed with other commercial wastes for disposal.

---

## RoHS



# Contents

FCC Compliance Statement . . . . .	3
Explanation of Graphical Symbols . . . . .	3
Compliance . . . . .	4
<b>About This Document . . . . .</b>	<b>13</b>
Overview of Contents . . . . .	13
Important Safeguards . . . . .	14
<b>1 Introduction . . . . .</b>	<b>17</b>
Features . . . . .	17
Technical Overview . . . . .	18
<b>2 Installation . . . . .</b>	<b>21</b>
Package Contents . . . . .	21
Required Installation Tools . . . . .	21
Connecting the Video Input . . . . .	22
Connecting the Loop-Through Video . . . . .	22
Connecting the Monitor . . . . .	23
Connecting a VGA Monitor . . . . .	24
Connecting Audio . . . . .	24
Connecting Alarms . . . . .	25
AI 1 to 16 (Alarm-In) . . . . .	25
GND (Ground) . . . . .	26
AO 1 to 16 (Alarm-Out) . . . . .	26
ARI (Alarm Reset In) . . . . .	26
Connecting to the RS485 Port . . . . .	27
Connecting to the USB Ports . . . . .	27
Connecting to the RS232 Port . . . . .	28
Connecting to the Ultra Wide SCSI Port . . . . .	28
Connecting to the Network Port . . . . .	29
Factory Reset . . . . .	30
Connecting the Power Cord . . . . .	31
<b>3 Configuration . . . . .</b>	<b>33</b>
Front Panel Controls . . . . .	33
Turning on the Power . . . . .	37
Initial Unit Setup . . . . .	37
Setup Screen . . . . .	38
System Information . . . . .	39
Date/Time Setup . . . . .	42
Storage Screen . . . . .	45
User Setup Screen . . . . .	48

## Contents

Shutdown Screen . . . . .	50
Logout Screen . . . . .	51
Network and Notification Setup . . . . .	51
Network Screen . . . . .	51
LAN Setup Screen . . . . .	52
Modem Setup . . . . .	56
DVRNS Setup . . . . .	57
WebGuard Setup . . . . .	58
Notification Setup . . . . .	59
Configuring Devices . . . . .	61
Camera Setup Screen . . . . .	62
Audio Setup Screen . . . . .	64
Alarm-Out Screen . . . . .	65
Display Screen . . . . .	66
Remote Control Screen . . . . .	69
Recording Settings . . . . .	70
Record Screen . . . . .	70
Schedule Screen . . . . .	71
Pre-Event Screen . . . . .	73
Archive Screen . . . . .	74
Event Settings . . . . .	75
Alarm-In Screen . . . . .	76
Motion Detection Screen . . . . .	78
Video Loss Screen . . . . .	83
Text-In Screen . . . . .	85
System Event Screen . . . . .	89
Event Status Screen . . . . .	93
<b>4 Operation . . . . .</b>	<b>95</b>
Turning on the Power . . . . .	95
Live Monitoring . . . . .	96
Active Cameo Mode . . . . .	97
PIP Mode . . . . .	97
Zoom Mode . . . . .	97
PTZ Mode . . . . .	97
Image Adjustment . . . . .	100
Event Monitoring . . . . .	100
Covert Camera . . . . .	101
Spot Monitoring . . . . .	101
Using a Mouse . . . . .	103
Recording Video . . . . .	104
Recording Audio . . . . .	105
Playing Recorded Video . . . . .	105
RW (Rewind) Button . . . . .	106
FF (Fast Forward) Button . . . . .	106
BACKWARD Button . . . . .	106
FORWARD Button . . . . .	106
SEARCH Button . . . . .	107
Camera Buttons (1 to 16) . . . . .	107
DISPLAY Button . . . . .	107
ZOOM Button . . . . .	107
Shuttle Ring . . . . .	107
Jog Dial . . . . .	107
Searching Video . . . . .	108

Contents

Go to the Date/Time . . . . .	109
Calendar Search. . . . .	110
Event Log Search . . . . .	111
Text-In Search . . . . .	113
Motion Search . . . . .	115
Clip-Copy Screen . . . . .	117
Print Screen . . . . .	120
<b>Appendix A USB Hard Disk Drive Preparation . . . . .</b>	<b>121</b>
Preparing the USB-IDE Hard Disk Drive in Windows 2000. . . . .	121
Preparing the USB-IDE Hard Disk Drive in Windows 98 . . . . .	122
<b>Appendix B Text In Search Examples . . . . .</b>	<b>123</b>
Search Example 1. . . . .	123
Search Example 2. . . . .	124
<b>Appendix C Reviewing Video Clips . . . . .</b>	<b>127</b>
<b>Appendix D WebGuard . . . . .</b>	<b>131</b>
Web Monitoring Mode . . . . .	133
Web Search Mode . . . . .	135
<b>Appendix E Time Overlap . . . . .</b>	<b>139</b>
<b>Appendix F Troubleshooting . . . . .</b>	<b>141</b>
<b>Appendix G Connector Pin Outs. . . . .</b>	<b>143</b>
I/O Connector Pin Outs . . . . .	143
RS485 Connector Pin Outs . . . . .	144
<b>Appendix H Map of Screens . . . . .</b>	<b>145</b>
<b>Appendix I System Log Notices . . . . .</b>	<b>147</b>
<b>Appendix J Error Code Notices . . . . .</b>	<b>149</b>
<b>Appendix K Specifications. . . . .</b>	<b>151</b>

## Contents



# Figures

Figure 1-1	Typical DVR Installation . . . . .	19
Figure 2-1	16-Channel DVR Rear Panel . . . . .	22
Figure 2-2	Video Input Connectors . . . . .	22
Figure 2-3	Video Loop-Through Connectors . . . . .	22
Figure 2-4	Video Out Connectors . . . . .	23
Figure 2-5	VGA Connector . . . . .	24
Figure 2-6	Audio In and Out Connectors . . . . .	24
Figure 2-7	Alarm Input Connectors . . . . .	25
Figure 2-8	Alarm Output Connectors . . . . .	26
Figure 2-9	Alarm Reset Input Connectors . . . . .	26
Figure 2-10	RS485 Connector . . . . .	27
Figure 2-11	Front USB Connectors . . . . .	27
Figure 2-12	Rear USB Connector . . . . .	27
Figure 2-13	RS232 Connector . . . . .	28
Figure 2-14	SCSI Connector . . . . .	28
Figure 2-15	Network Connector . . . . .	29
Figure 2-16	Factory Reset Switch . . . . .	30
Figure 2-17	Power Cord Connector . . . . .	31
Figure 3-1	16-Channel DVR Front Panel . . . . .	33
Figure 3-2	Infrared Remote Control . . . . .	34
Figure 3-3	Login Screen . . . . .	38
Figure 3-4	Setup Screen . . . . .	38
Figure 3-5	Virtual Keyboard . . . . .	39
Figure 3-6	Information Screen . . . . .	39
Figure 3-7	Upgrade Screen . . . . .	40
Figure 3-8	Setup Import Screen . . . . .	41
Figure 3-9	Setup Export Screen . . . . .	41
Figure 3-10	System Log Screen . . . . .	42
Figure 3-11	Date/Time Setup Screen . . . . .	43
Figure 3-12	Holiday Setup Screen . . . . .	44
Figure 3-13	Time Sync. Screen . . . . .	44
Figure 3-14	Storage Information Screen . . . . .	45
Figure 3-15	Device Format Screen . . . . .	46

## Figures

Figure 3-16	Device Information Screen . . . . .	46
Figure 3-17	Storage Status Screen . . . . .	47
Figure 3-18	User Setup Screen . . . . .	48
Figure 3-19	New Group Setup Screen . . . . .	49
Figure 3-20	New User Setup Screen . . . . .	50
Figure 3-21	Shutdown Screen . . . . .	51
Figure 3-22	Logout Screen . . . . .	51
Figure 3-23	Network Menu . . . . .	51
Figure 3-24	Network Setup Screen . . . . .	52
Figure 3-25	LAN (Manual) Setup Screen . . . . .	53
Figure 3-26	Port Numbers Setup Screen . . . . .	54
Figure 3-27	LAN (DHCP) Setup Screen . . . . .	55
Figure 3-28	LAN (ADSL) Setup Screen . . . . .	55
Figure 3-29	Modem Setup Screen . . . . .	56
Figure 3-30	DVRNS Setup Screen . . . . .	57
Figure 3-31	WebGuard Setup Screen . . . . .	59
Figure 3-32	Notification Mail Setup Screen . . . . .	59
Figure 3-33	Authentication Setup Screen . . . . .	60
Figure 3-34	Notification Callback Setup Screen . . . . .	61
Figure 3-35	Device Menu . . . . .	62
Figure 3-36	Camera Setup Screen . . . . .	62
Figure 3-37	Camera PTZ Setup Screen . . . . .	63
Figure 3-38	PTZ Device List . . . . .	63
Figure 3-39	Port Setup Window . . . . .	64
Figure 3-40	Audio Setup Screen . . . . .	64
Figure 3-41	Alarm-Out Settings Screen . . . . .	65
Figure 3-42	Alarm-Out Schedule Screen . . . . .	65
Figure 3-43	Display OSD Screen . . . . .	66
Figure 3-44	OSD Margin Screen . . . . .	67
Figure 3-45	Main Monitor Screen . . . . .	68
Figure 3-46	Spot Monitor Screen . . . . .	69
Figure 3-47	Remote Control Setup Screen . . . . .	69
Figure 3-48	Record Menu . . . . .	70
Figure 3-49	Record Setup Screen . . . . .	70
Figure 3-50	Schedule Setup Screen . . . . .	72
Figure 3-51	Default Setup Screen . . . . .	73
Figure 3-52	Pre-Event Setup Screen . . . . .	73
Figure 3-53	Archive Setup Screen . . . . .	74
Figure 3-54	Event Menu . . . . .	75
Figure 3-55	Alarm-In Settings Screen . . . . .	76
Figure 3-56	Alarm-In Actions 1 Screen . . . . .	76
Figure 3-57	Alarm-In Notify Menu . . . . .	77
Figure 3-58	Alarm-In Actions 2 Screen . . . . .	78

## Figures

Figure 3-59	Motion Detection Settings Screen . . . . .	78
Figure 3-60	Motion Detection Sensitivity Screen . . . . .	79
Figure 3-61	Motion Detection Min. Blocks Screen . . . . .	79
Figure 3-62	Motion Detection Zone Screen. . . . .	79
Figure 3-63	Motion Detection Zone Menu . . . . .	80
Figure 3-64	Daytime Setup Screen . . . . .	80
Figure 3-65	Motion Detection Actions 1 Screen . . . . .	81
Figure 3-66	Motion Detection Actions 2 Screen . . . . .	82
Figure 3-67	Video Loss Settings Screen . . . . .	83
Figure 3-68	Video Loss Actions 1 Screen. . . . .	83
Figure 3-69	Video Loss Actions 2 Screen. . . . .	84
Figure 3-70	Text-In Settings Screen. . . . .	85
Figure 3-71	Text-In Device (VP Filter) Settings Screen . . . . .	86
Figure 3-72	Text-In Device (Generic Text and EPSON-POS) Settings Screen. . . . .	86
Figure 3-73	Text-In Actions 1 Screen . . . . .	88
Figure 3-74	Text-In Actions 2 Screen . . . . .	89
Figure 3-75	Health Check Screen. . . . .	90
Figure 3-76	Check Recording Screen. . . . .	90
Figure 3-77	Storage Screen. . . . .	91
Figure 3-78	S.M.A.R.T. Setup Screen. . . . .	91
Figure 3-79	System Event Actions Screen . . . . .	92
Figure 3-80	Event Status Screen . . . . .	93
Figure 4-1	PTZ Select Camera Menu . . . . .	98
Figure 4-2	PTZ Set Preset Screen . . . . .	98
Figure 4-3	PTZ Preset View Screen . . . . .	99
Figure 4-4	PTZ Menu. . . . .	99
Figure 4-5	PTZ Controls . . . . .	99
Figure 4-6	Spot Monitor Menu . . . . .	102
Figure 4-7	Sequence Menu . . . . .	102
Figure 4-8	Mouse Menu . . . . .	103
Figure 4-9	Mouse Display Menu . . . . .	104
Figure 4-10	Mouse Playback Controls . . . . .	108
Figure 4-11	Search Menu . . . . .	109
Figure 4-12	Go to the Date/Time Screen . . . . .	109
Figure 4-13	Calendar Search Screen . . . . .	110
Figure 4-14	Event Log Search Screen . . . . .	111
Figure 4-15	Event Log Search Option Screen . . . . .	112
Figure 4-16	Text-In Search Screen . . . . .	113
Figure 4-17	Text-In Search Option Screen . . . . .	114
Figure 4-18	Motion Search Screen . . . . .	115
Figure 4-19	Motion Search Option Screen . . . . .	116
Figure 4-20	Clip-Copy Screen. . . . .	117
Figure 4-21	Print Screen. . . . .	120

## Figures

Figure B-1	Text-In Search Option Example 1 . . . . .	.124
Figure B-2	Text-In Search Option Example 2 . . . . .	.125
Figure C-1	Clip Player Screen . . . . .	.127
Figure D-1	WebGuard Login Screen . . . . .	.132
Figure D-2	WebGuard Screen . . . . .	.133
Figure D-3	WebSearch Screen . . . . .	.135

# About This Document

This document introduces the HRXD Series Digital Video Recorder (DVR) and describes how to install, configure, and operate the DVR.

This guide covers the 9- and 16-channel HRXD Series DVRs. The DVRs are identical except for the number of cameras and alarms that can be connected and the number of cameras that can be displayed. For simplicity, the illustrations and descriptions in this guide refer to the 16-camera model.

---

## Overview of Contents

---

This document contains the following chapters and appendices:

- *Chapter 1, Introduction*, introduces the HRXD Series DVR, lists the features and gives a functional overview of its components.
- *Chapter 2, Installation*, describes how to install the DVR and connect the system components.
- *Chapter 3, Configuration*, provides an overview of the front panel controls and LCD displays and provides instructions for configuring the DVR.
- *Chapter 4, Operation*, covers live monitoring, recording video and audio, playing recorded video, and searching for video.
- *Appendix A, USB Hard Disk Drive Preparation*, shows how to prepare the USB hard disk drive for computers using Microsoft® Windows® 2000/98 operating systems.
- *Appendix B, Text In Search Examples*, provides typical examples of text searches.
- *Appendix C, Reviewing Video Clips*, describes the Clip Player program and its features.
- *Appendix D, WebGuard*, demonstrates using WebGuard to access a remote DVR, monitor live video and search for recorded video using Internet Explorer.
- *Appendix E, Time Overlap*, instructs how to search for recorded video when you have overlapping time segments.
- *Appendix F, Troubleshooting*, provides answers for common technical issues.
- *Appendix G, Connector Pin Outs*, describes I/O and RS485 connector pinouts.

- *Appendix H, Map of Screens*, provides a graphical illustration of the menu screens.
- *Appendix I, System Log Notices*, lists all of the System Log notices.
- *Appendix J, Error Code Notices*, lists the system upgrade and clip copy Error Code notices.
- *Appendix K, Specifications*, lists the DVR specifications.

---

## Important Safeguards

---

1. Read Instructions

All the safety and operating instructions should be read before the appliance is operated.

2. Retain Instructions

The safety and operating instructions should be retained for future reference.

3. Cleaning

Unplug this equipment from the wall outlet before cleaning it. Do not use liquid aerosol cleaners. Use a damp soft cloth for cleaning.

4. Attachments

Never add any attachments and/or equipment without the approval of the manufacturer as such additions may result in the risk of fire, electric shock, or other personal injury.

5. Water and/or Moisture

Do not use this equipment near water or in contact with water.

6. Accessories

Do not place this equipment on an unstable cart, stand, or table. The equipment may fall, causing serious injury to a child or adult, and serious damage to the equipment. Wall or shelf mounting should follow the manufacturer's instructions, and should use a mounting kit approved by the manufacturer.



This equipment and cart combination should be moved with care. Quick stops, excessive force, and uneven surfaces may cause the equipment and cart combination to overturn.

7. Power Sources

This equipment should be operated only from the type of power source indicated on the marking label. If you are not sure of the type of power, please consult your equipment dealer or local power company.

8. Power Cords

Operator or installer must remove power, BNC, alarm, and other connections before moving the equipment.

9. Lightning

For added protection for this equipment during a lightning storm, or when it is left unattended and unused for long periods of time, unplug it from the wall outlet and disconnect the antenna or cable system. This will prevent damage to the equipment due to lightning and power-line surges.

10. Overloading

Do not overload wall outlets and extension cords to avoid the risk of fire or electric shock.

11. Objects and Liquids

Never push objects of any kind through openings of this equipment as they may touch dangerous voltage points or short out parts that could result in a fire or electric shock. Never spill liquid of any kind on the equipment.

12. Servicing

Do not attempt to service this equipment yourself. Refer all servicing to qualified service personnel.

13. Damage Requiring Service

Unplug this equipment from the wall outlet and refer servicing to qualified service personnel under the following conditions:

- When the power-supply cord or the plug has been damaged
- If liquid is spilled or objects have fallen into the equipment
- If the equipment has been exposed to rain or water
- If the equipment does not operate normally by following the operating instructions, adjust only those controls that are covered by the operating instructions as an improper adjustment of other controls may result in damage and will often require extensive work by a qualified technician to restore the equipment to its normal operation.
- If the equipment has been dropped or the cabinet damaged
- When the equipment exhibits a distinct change in performance—this indicates a need for service.

14. Replacement Parts

When replacement parts are required, be sure the service technician has used replacement parts specified by the manufacturer or that have the same characteristics as the original part. Unauthorized substitutions may result in fire, electric shock, or other hazards.

15. Safety Check

Upon completion of any service or repairs to this equipment, ask the service technician to perform safety checks to determine that the equipment is in proper operating condition.

16. Field Installation

This installation should be made by a qualified service person and should conform to all local codes.

## 17. Correct Batteries

---

**WARNING!** Risk of explosion if battery is replaced by an incorrect type. Dispose of used batteries according to the instructions.

---

## 18. Operating Temperature

An operating temperature range is specified (see *Appendix K, Specifications*) so that the customer and installer may determine a suitable operating environment for the equipment.

## 19. Elevated Operating Ambient Temperature

If installed in a closed or multi-unit rack assembly, the operating ambient temperature of the rack environment may be greater than room ambient. Therefore, consideration should be given to installing the equipment in an environment compatible with the specified operating temperature range.

## 20. Reduced Air Flow

Installation of the equipment in the rack should be such that the amount of airflow required for safe operation of the equipment is not compromised.

## 21. Mechanical Loading

Mounting of the equipment in the rack should be such that a hazardous condition is not caused by uneven mechanical loading.

## 22. Circuit Overloading

Consideration should be given to connection of the equipment to supply circuit and the effect that overloading of circuits might have on over-current protection and supply wiring. Appropriate consideration of equipment nameplate ratings should be used when addressing this concern.

## 23. Reliable Earthing (Grounding)

Reliable grounding of rack mounted equipment should be maintained. Particular attention should be given to supply connections other than direct connections to the branch circuit (for example, use of power strips).



# Introduction

---

## Features

---

Your color digital video recorder (DVR) provides recording capabilities for nine or 16 camera inputs. It provides exceptional picture quality in both live and playback modes, and offers the following features:

- 9 or 16 composite video input connectors
- Compatible with color (NTSC or PAL) and B&W (CCIR and EIA-170) video sources
- Auto detection for NTSC and PAL
- Multiple monitor connectors: 1 BNC Video Out, 1 SVHS, 4 Spot, 1 VGA
- Multiple search engines (Date/Time, Calendar, Event)
- Records up to 240/200 images per second (NTSC/PAL)
- “Loop-Through” video connectors
- Continuous recording in Disk Overwrite mode
- Video archiving via Ultra SCSI interface
- 3 USB 2.0 ports
- Continues recording while archiving and transmitting to remote sites during playback
- User-friendly Graphical User Interface (GUI) menu system
- Multiple recording modes (Time-lapse, Pre-event, Alarm, Motion and Panic)
- 4-Channel audio recording and 1-channel audio playback
- Text input for ATM and POS
- Alarm connections include: Input, Output and Reset Input
- Built-in alarm buzzer
- Live or recorded video access via Ethernet or modem
- Time synchronization using industry standard protocol
- Built-in CD-RW or DVD-RW drive
- Self-diagnostics with automatic notification including hard disk drive S.M.A.R.T. protocol
- Infrared remote control

---

## Technical Overview

---

In addition to replacing both a time-lapse VCR and a multiplexer in a security installation, your DVR has many features that make it much more powerful and easier to use than even the most advanced VCR.

The DVR converts analog NTSC or PAL video to digital images and records them on a hard disk drive. Using a hard disk drive allows you to access recorded video almost instantaneously; there is no need to rewind tape. The technology also allows you to view recorded video while the DVR continues recording video.

Digitally recorded video has several advantages over analog video recorded on tape. There is no need to adjust tracking. You can freeze frames, fast forward, fast reverse, slow forward and slow reverse without image streaking or tearing. Digital video can be indexed by time or events, and you can instantly view video after selecting the time or event.

Your DVR can be set up for event or time-lapse recording. You can define times to record, and the schedule can change for different days of the week and user-defined holidays.

The DVR can be set up to alert you when the hard disk drive is full, or it can be set to record over the oldest video once the disk is full.

Your DVR uses a proprietary encryption scheme making it nearly impossible to alter video.

You can view video and control your DVR remotely by connecting via modem or Ethernet. There is a SCSI port that can be used to record or archive video to external hard disk drives, and there are also three USB ports that can be used to upgrade the system or copy video clips to external hard disk, CD-RW and flash drives.

---

**Note** This manual covers the 9- and 16-channel digital video recorders. The DVRs are identical except for the number of cameras and alarms that can be connected and the number of cameras that can be displayed. For simplicity, the illustrations and descriptions in this manual refer to the 16-camera model.

---

**Figure 1-1 Typical DVR Installation**

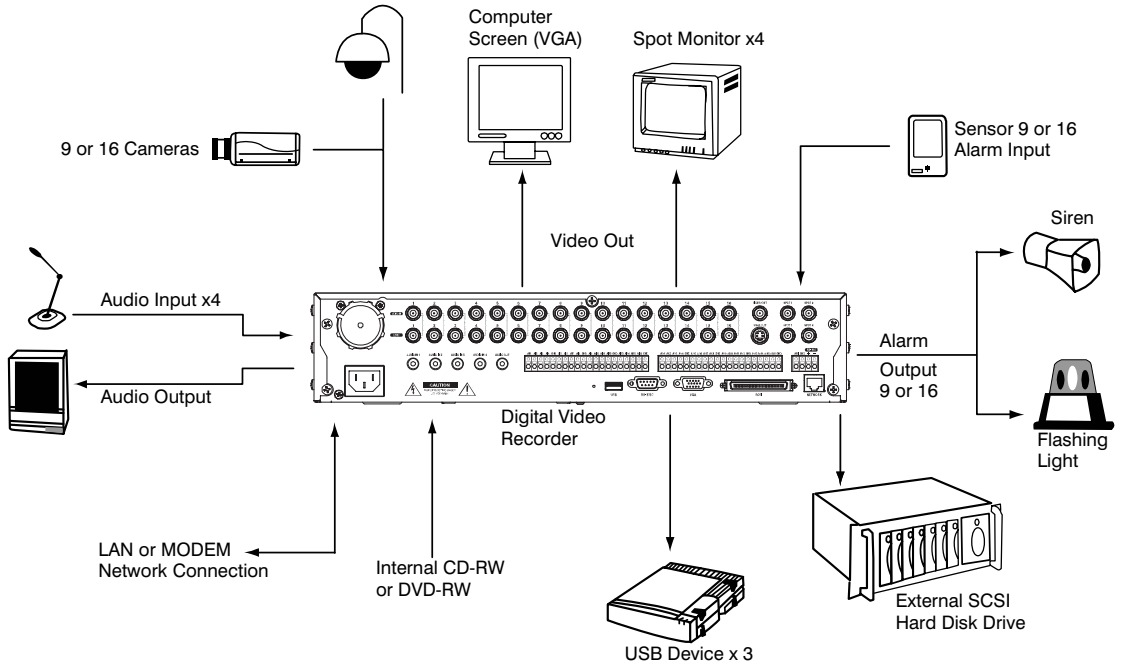



## Installation

---

### Package Contents

---

The package contains the following:

- Digital Video Recorder
- Power cord
- User Guide (this document)
- Multilingual User Guide (RASplus CD-ROM)
- RASplus User Guide
- Multilingual RASplus Software CD and User Guide (RASplus CD-ROM)
- DVRNS Server Software and User Guide (RASplus CD-ROM)
- Rack-mount kit
- Assembly screws guide rails for adding Hard Disk drives
- Screws for attaching SCSI connector
- Infrared remote control

---

### Required Installation Tools

---

No special tools are required to install the DVR. Refer to the installation manuals for the other items that make up part of your system.

**Figure 2-1 16-Channel DVR Rear Panel**

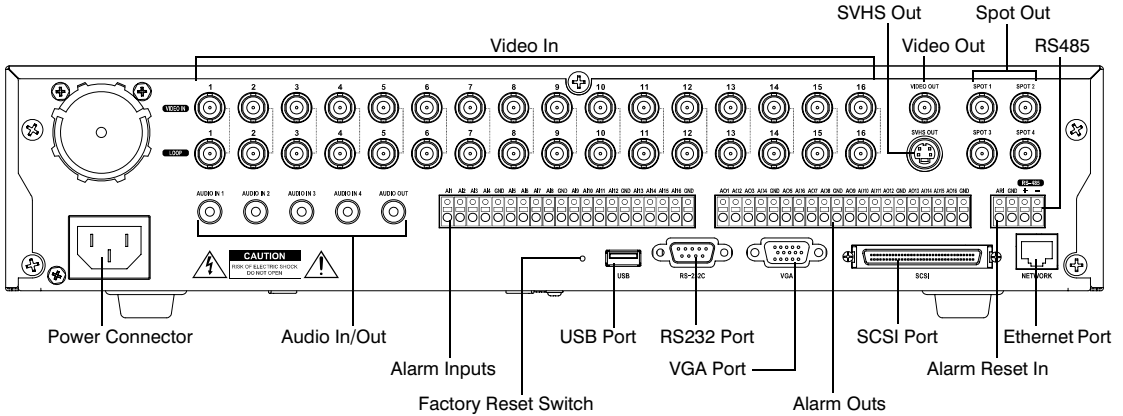

Your DVR can be used with either NTSC or PAL equipment.

---

**Note** You cannot mix NTSC and PAL equipment. For example, you cannot use a PAL camera and an NTSC monitor.

---

---

## Connecting the Video Input

---

**Figure 2-2 Video Input Connectors**

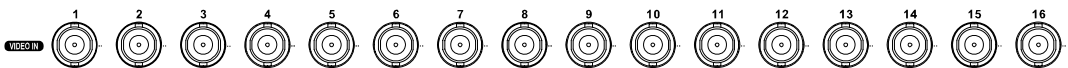

Connect the coaxial cables from the video sources to the BNC Video In connectors.

---

## Connecting the Loop-Through Video

---

**Figure 2-3 Video Loop-Through Connectors**

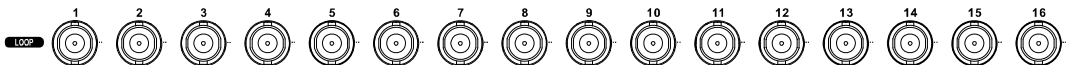

If you would like to connect your video source to another device, you can use the Loop BNC connectors.

---

**Note** The Loop BNC connectors are auto terminated. Do NOT connect a cable to the Loop BNC unless it is connected to a terminated device because it will cause poor quality video.

---

---

## Connecting the Monitor

---

**Figure 2-4** Video Out Connectors

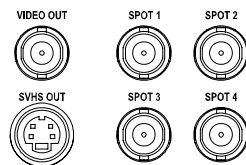

Connect the main monitor to either the Video Out or SVHS Out connector.

---

**Note** Use the SVHS input if your main monitor supports it because it will give you better quality video display.

---

---

**Note** The Video Out (BNC) and SVHS Out connectors may be connected to individual monitors for simultaneous operation.

---

Up to four Spot monitors can be connected to the DVR. Connect the spot monitors to the SPOT 1, SPOT 2, SPOT 3 and SPOT 4 connectors as needed.

---

**Note** When the DVR is in Search mode, it can display live video on the SPOT 1 monitor as displayed on the main monitor during the live mode.

---

---

## Connecting a VGA Monitor

---

**Figure 2-5** VGA Connector

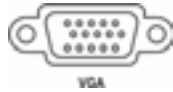

A VGA connector is provided so that you can use a standard, multi-sync computer monitor as your main monitor. Use the cable supplied with your monitor to connect it to the DVR.

---

**Note** Pressing and holding **DISPLAY** on the front panel for 5 seconds or longer will switch the video output between Video Out (BNC or SVHS Out) and VGA Out. During clip copy, you cannot switch the video output between Video Out and VGA Out.

---

---

**Caution** The DVR will NOT record video for about 3 seconds while switching the video output between Video Out and VGA Out.

---

---

## Connecting Audio

---

---

**Note** It is the user's responsibility to determine if local laws and regulations permit recording audio.

---

**Figure 2-6** Audio In and Out Connectors





Your DVR can record audio from up to four sources. Connect the audio sources to Audio In 1, Audio In 2, Audio In 3 and Audio In 4 as needed using RCA jacks. Connect Audio Out to your amplifier.

---

**Note** The DVR does not have amplified audio output, so you will need a speaker with an amplifier. The DVR does not have a pre-amplifier for audio input, so the audio input should be from an amplified source, not directly from a microphone.

---

---

## Connecting Alarms

---

**Figure 2-7 Alarm Input Connectors**

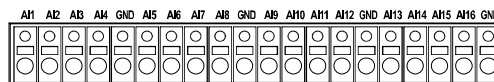

---

**Note** To make connections on the Alarm Connector strip, press and hold the button and insert the wire in the hole below the button. After releasing the button, tug gently on the wire to make certain it is connected. To disconnect a wire, press and hold the button above the wire and pull out the wire.

---

### AI 1 to 16 (Alarm-In)

You can use external devices to signal the DVR to react to events. Mechanical or electrical switches can be wired to the AI (Alarm-In) and GND (Ground) connectors. The threshold voltage is 4.3V and should be stable at least 0.5 seconds to be detected. See [Chapter 3, Configuration](#) for configuring alarm input.

## GND (Ground)

---

**Note** All the connectors marked GND are common.

---

Connect the ground side of the alarm input and/or alarm output to the GND connector.

## AO 1 to 16 (Alarm-Out)

**Figure 2-8 Alarm Output Connectors**

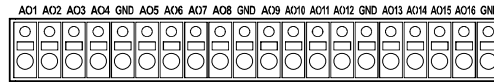

The DVR can activate external devices such as buzzers or lights. Connect the device to the AO (Alarm-Out) and GND (Ground) connectors. AO is an active low open collector output which sinks 5 mA@12V and 30 mA@5V. See *Chapter 3, Configuration* for configuring alarm outputs.

## ARI (Alarm Reset In)

**Figure 2-9 Alarm Reset Input Connectors**



An external signal to the Alarm Reset In can be used to reset both the Alarm Out signal and the DVR's internal buzzer. Mechanical or electrical switches can be wired to the ARI (Alarm Reset In) and GND (Ground) connectors. The threshold voltage is below 0.3V and should be stable at least 0.5 seconds to be detected. Connect the wires to the ARI (Alarm Reset In) and GND (Ground) connectors.

---

## Connecting to the RS485 Port

---

**Figure 2-10** RS485 Connector

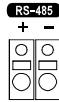

The DVR can be controlled remotely by an external device or control system, such as a control keyboard, using RS485 half-duplex serial communications signals. The RS485 connector can also be used to control PTZ (pan, tilt, zoom) cameras. Connect RX-/TX- and RX+/TX+ of the control system to the - and + (respectively) of the DVR. See [Chapter 3, Configuration](#) and the PTZ camera or remote controller manufacturer's manual for configuring the RS485 connection.

---

## Connecting to the USB Ports

---

**Figure 2-11** Front USB Connectors



**Figure 2-12** Rear USB Connector



Three USB ports are provided to connect external hard disk, CD-RW or flash drives for video clip copying or system upgrades. One USB port is located on the rear panel and the other two are on the front panel. Position external drives close enough to the DVR so that you can make the cable connections, usually less than 6 feet. Use the USB cable provided with the hard disk drive to connect it to the DVR.

A USB mouse (not supplied) can be connected to one of the ports. You can use the mouse to navigate through the screens and menus much like you would on a computer.

A PostScript™ USB printer (not supplied) can be connected to one of the ports. You can print selected images resulting from a search. Refer to [Chapter 4, Operation, Searching Video](#).

A USB to Serial converter can be connected to the USB port. Multiple text-in devices can be used with a USB to Serial converter.

---

## Connecting to the RS232 Port

---

**Figure 2-13** RS232 Connector

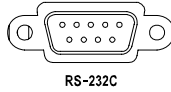

An RS232 port is provided to connect an external modem for remote monitoring, configuration and software upgrades, and to connect a remote control keyboard. Use a modem cable with a DB-9S (female) connector to connect to the DVR. See [Chapter 3, Configuration](#) for configuring the modem.

---

**Note** The DVR is not supplied with a modem cable, and many modems are not supplied with cables. Make certain you have the correct cable when purchasing the modem.

---

---

## Connecting to the Ultra Wide SCSI Port

---

**Figure 2-14** SCSI Connector

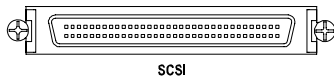

A SCSI port is provided to connect external storage devices for recording or archiving video. Connect the external SCSI hard disk drive (RAID) cable to the high-density 68-pin female UltraWide SCSI port. The length of SCSI cable should not exceed 5 feet (1.5 meters). You can connect up to 8 UltraWide SCSI devices with SCSI IDs set from 0 to 15 except for 7, which is assigned as the Host ID.

---

**Note** The SCSI bus must be terminated, otherwise the DVR will not operate properly.

---

---

**Caution** Do NOT connect or disconnect SCSI devices while the DVR power is on. The DVR must be powered down to connect or disconnect SCSI devices. Power up SCSI devices so they are ready for operation before powering up the DVR. Power down SCSI devices after powering down the DVR and then disconnect SCSI devices.

---

---

**Caution** If the SCSI device is shut down while the device is operating, the DVR system might not operate normally.

---

---

## Connecting to the Network Port

---

**Figure 2-15** Network Connector



The DVR can be networked using the 10/100Mb Ethernet connector. Connect a Cat5 cable with an RJ-45 jack to the DVR connector. The DVR can be networked with a computer for remote monitoring, searching, configuration and software upgrades. See [Chapter 3, Configuration](#) for configuring the Ethernet connections.

---

**Caution** The network connector is not designed to be connected with cable or wire intended for outdoor use.

---

---

## Factory Reset

---

**Figure 2-16** Factory Reset Switch

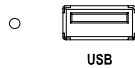

The DVR has a Factory Reset switch to the left of the USB port on the rear panel. This switch will only be used on the rare occasions that you want to return all the settings to the original factory settings.

---

**Caution** When using the Factory Reset, you will lose any settings you have saved.

---

To reset the unit, you will need a straightened paperclip:

1. Turn the DVR off.
2. Turn it on again.
3. While the DVR is initializing, the front panel LEDs will blink. When any of the Camera 1 to 8 LEDs blink, poke the straightened paperclip in the unlabeled hole to the left of the USB port.
4. Hold the switch until all the LEDs on the front panel are lit.

---

**Note** When the DVR successfully resets to factory defaults, all the LEDs on the front panel will flash five times.

---

5. Release the reset switch. All of the DVR's settings are now at the original settings it had when it left the factory.

---

## Connecting the Power Cord

---

**Figure 2-17** Power Cord Connector

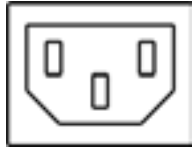

Connect the AC power cord to the DVR and then to a wall outlet.

---

**WARNING!** ROUTE POWER CORDS SO THAT THEY ARE NOT A TRIPPING HAZARD. MAKE CERTAIN THE POWER CORD WILL NOT BE PINCHED OR ABRADED BY FURNITURE. DO NOT INSTALL POWER CORDS UNDER RUGS OR CARPET.  
THE POWER CORD HAS A GROUNDING PIN. IF YOUR POWER OUTLET DOES NOT HAVE A GROUNDING PIN RECEPTACLE, DO NOT MODIFY THE PLUG.  
DO NOT OVERLOAD THE CIRCUIT BY PLUGGING TOO MANY DEVICES IN TO ONE CIRCUIT.

---

---

**Caution** In noisy electrical environments, use an Uninterruptible Power Supply (UPS) to minimize the potential of damage to the DVR from undesired power related hazards. Connect the UPS between the DVR and the AC voltage supply.

---

Your DVR is now ready to operate. Refer to *Chapter 3, Configuration* and *Chapter 4, Operation* to use the DVR.





# Configuration

**Note** Your DVR should be completely installed before proceeding. Refer to *Chapter 2, Installation*.

## Front Panel Controls

**Figure 3-1 16-Channel DVR Front Panel**

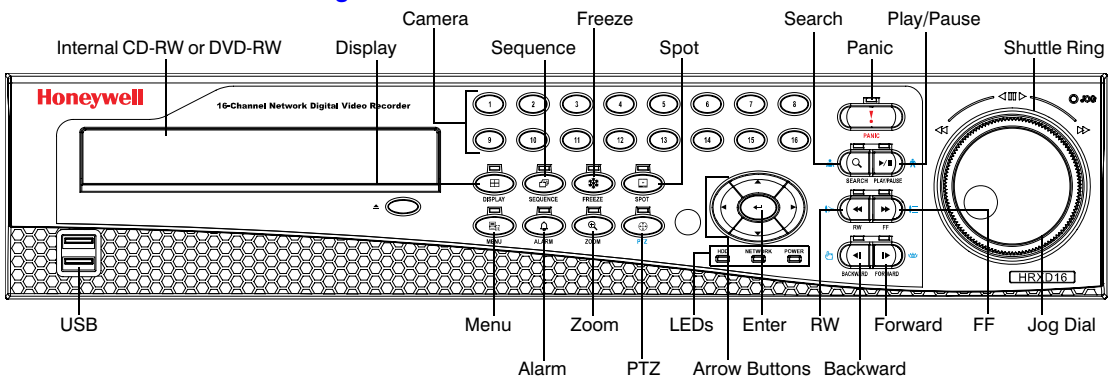

The front panel looks and operates much like a VCR combined with a multiplexer. Many of the buttons have multiple functions. The buttons on the infrared remote control, while laid out differently, perform the same functions as those on the front panel. The following describes each button and control. Take a few minutes to review the descriptions. You will use these to initially set up your DVR and for daily operations.

---

**Note** The infrared sensor on the DVR is just to the left of the arrow buttons. Make certain that nothing blocks the sensor, or the remote control will not function properly.

---

**Note** You can also use a USB mouse (not supplied) to navigate through the screens and menus much like you would on a computer.

---

**Figure 3-2 Infrared Remote Control**

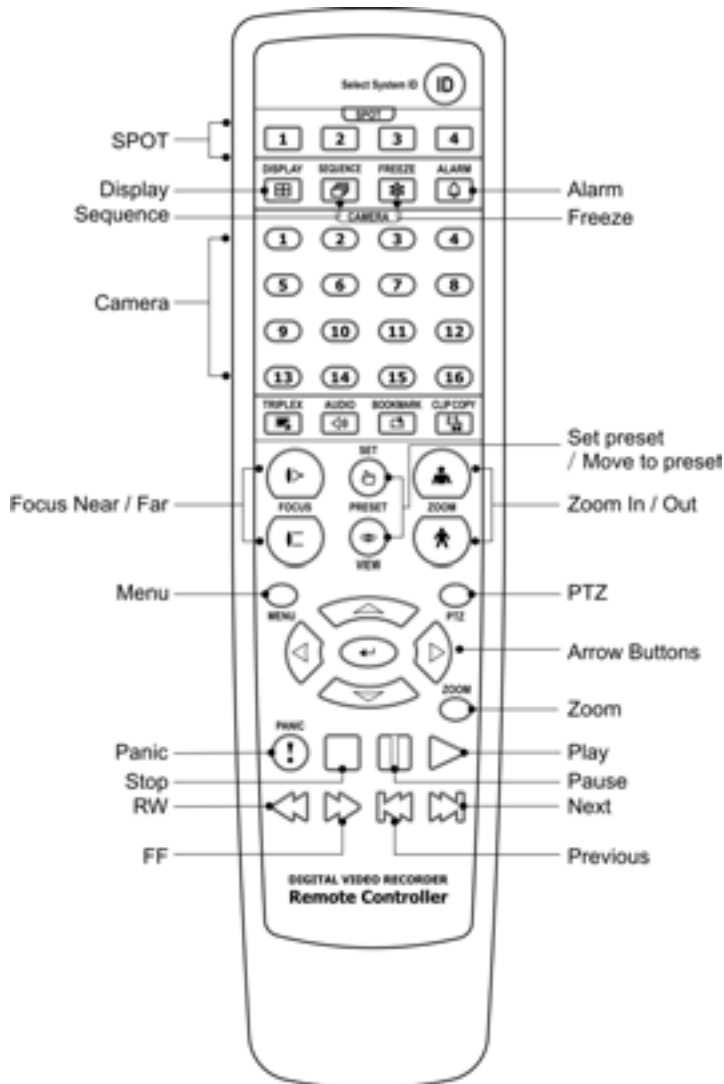

---























**Note** Some buttons on the infrared remote control may not be supported, depending on the DVR model.

---

**Table 3-1 Front Panel Buttons and Controls**

<b>Control</b>	<b>Description</b>
Camera Buttons (1 to 16)	Pressing the individual camera buttons will cause the selected camera to display full screen. Buttons 1 to 9 are also used to enter passwords.
DISPLAY Button	The <b>DISPLAY</b> button has two functions. First, it toggles between different display formats. The available formats are: 4x4, 3x3, 2x2 and PIP. Second, pressing and holding the button for 5 seconds or longer will switch the video output between Video Out (BNC or SVHS Out) and VGA Out.
SEQUENCE Button	When in the live mode, pressing the <b>SEQUENCE</b> button displays live channels sequentially.
FREEZE Button	Pressing the <b>FREEZE</b> button freezes the current live screen.
SPOT Button	Pressing the <b>SPOT</b> button allows you to select which cameras will display on the four Spot monitors. After selecting the monitor you can opt to have that Spot monitor display a single camera or all cameras sequentially. The infrared remote control allows you to go directly to the individual Spot monitor menus.
MENU Button	Pressing the <b>MENU</b> button enters the Setup screen. You will need to enter the authorized user name and password to access Setup. Pressing the button also closes the current menu or setup dialog box. In Playback mode, pressing <b>MENU</b> displays the Search menu. In Search mode clip-copying can be done instantly by pressing and holding the button for two or more seconds.
ALARM Button	The <b>ALARM</b> button has two functions. First, it will reset the DVR's outputs including the internal buzzer during an alarm. Second, it will display the event log when you are in the live monitoring mode unless there is an active alarm. This operation can be user password protected.
ZOOM Button	Pressing the <b>ZOOM</b> button zooms the current image on the screen. A PIP with a rectangle temporarily displays showing what area of the screen has been enlarged. You can use the arrow buttons to move the rectangle to another area. Pressing <b>↵</b> (Enter) toggles the zoom size between 2x, 3x and 4x.
PTZ Button	Pressing the <b>PTZ</b> button enters the PTZ (Pan/Tilt/Zoom) mode which allows you to control properly configured cameras.
Up, Down, Left, Right Arrow Buttons	<p>These buttons are used to navigate through menus and GUI. You can also use them to change numbers by highlighting a number in the menu and using the <b>Up</b> and <b>Down</b> arrow buttons to increase or decrease the number's value.</p> <p>The arrow buttons are also used to control Pan and Tilt when in the PTZ mode. When in the PIP display format, pressing the <b>Up</b> and <b>Down</b> arrow buttons moves the position of the small screen counter-clockwise and clockwise, and pressing the <b>Left</b> and <b>Right</b> buttons moves through screen pages.</p>
PANIC Button	Pressing the <b>PANIC</b> button starts panic recording of all camera channels, and displays <b>!</b> on the screen. Pressing the button again will stop panic recording.

**Table 3-1 Front Panel Buttons and Controls (cont'd)**

<b>Control</b>	<b>Description</b>
HDD LED	The HDD LED flickers when the DVR is recording or searching video on the hard disk drive.
NETWORK LED	The NETWORK LED flickers when the unit is connected to a network via either Ethernet or modem.
POWER LED	The POWER LED is lit when the unit is On.
Enter Button	The  (Enter) button selects a highlighted item or completes an entry that you have made during system setup.
SEARCH Button	Pressing the <b>SEARCH</b> button enters the Search menu. Pressing the button again exits Search mode. You will need to log into the system as a qualified user to enter Search mode from Live Monitoring mode. The button on the front panel is also used to Zoom In while in the PTZ mode.
PLAY/PAUSE Button	Pressing the <b>PLAY/PAUSE</b> button plays back images at regular speed. Pressing the button while in Playback mode pauses the video. The screen displays  when the DVR is playing back video and displays  when in the Pause mode. The button on the front panel is also used to Zoom Out while in the PTZ mode.
RW (Rewind) Button	Pressing the <b>RW</b> button plays video backward at high speed. Pressing the button again toggles the playback speed from  ,  and  . The screen displays  ,  and  respectively. The button is also used for Near Focus in the PTZ mode.
FF (Fast Forward) Button	Pressing the <b>FF</b> button plays video forward at high speed. Pressing the button again toggles the playback speed from  ,  and  . The screen displays  ,  and  respectively. The button is also used for Far Focus while in the PTZ mode.
FORWARD Button	Pressing the <b>FORWARD</b> button goes to the next image. The button on the front panel is also used to load a Preset View in the PTZ mode.
BACKWARD Button	Pressing the <b>BACKWARD</b> button goes to the previous image. The button on the front panel is also used to save Presets while in the PTZ mode.
Shuttle Ring	The Shuttle Ring only functions in Playback mode. The Shuttle Ring is spring loaded and returns to the center position when released. Turning the ring clockwise plays video forward. Turning the ring counterclockwise plays video backward. Playback speed varies with the amount the ring is turned. The playback speeds are  ,  ,  ,  x0.5,  ,  and  .  When you release the ring, it snaps back to the center position and the video pauses.

**Table 3-1 Front Panel Buttons and Controls (cont'd)**

<b>Control</b>	<b>Description</b>
Jog Dial	<p>When in playback mode, you can play video forward image-by-image by turning the Jog Dial clockwise and backward image-by-image by turning the Jog Dial counterclockwise.</p> <p>When in PIP mode, you can make the PIP screen smaller by turning the Jog Dial clockwise and larger by turning the Jog Dial counterclockwise.</p> <p>When in Setup mode, you can change number values by highlighting the item in the menu and turning Jog Dial clockwise or counterclockwise to increase or decrease the number.</p>
ID Button on Remote Control	<p>If a DVR System ID is set to 0, the infrared remote control will control that DVR without any additional operations. (Refer to <i>Figure 3-6, Information Screen</i>, in this chapter for further information on setting the System ID.) If the system ID is 1 to 16, you must to press the <b>ID</b> button on the remote control and then press the corresponding number button (1 to 16) in order to control that DVR. If the System ID of two or more DVRs is set to 0, those DVRs will react to the infrared remote control at the same time.</p>

---

## Turning on the Power

---



Connecting the power cord to the DVR turns on the unit. The unit takes approximately 60 seconds to initialize.

---

## Initial Unit Setup

---

Before using your DVR for the first time, you will want to establish the initial settings. This includes settings such as time and date, display language, camera, audio, remote control, record mode, network and password. Your DVR can be set up using various screens and dialog boxes.

Throughout the screens you will see . Highlighting  and pressing  gives you the opportunity to reset that screen to its default settings.

Press **MENU** to enter the setup screens. The **Login** screen appears.

**Figure 3-3 Login Screen**



Select a User and enter the password by pressing the appropriate combination of Camera number buttons and then **↵**. There is no default password when logging in the **admin** user for the first time.

---

**Note** To assure the secure management of the system, setting up a password is strongly recommended.

---

---

**Note** You can use a mouse (not supplied) to access the **Login** screen in addition to using the front panel buttons or the infrared remote control. Click the right mouse button to display the **Login** screen. To enter a password, click the ... button, and the virtual keyboard displays. See *Figure 3-5* to use the virtual keyboard.

---

---

## Setup Screen

---

**Figure 3-4 Setup Screen**



Press **MENU** to enter the setup screen.

While setting up the DVR, there will be many opportunities to enter names and titles. When making these entries, a Virtual Keyboard will appear.

**Figure 3-5 Virtual Keyboard**



Use the arrow keys to highlight the character you want in the name or title and press **←**. That character appears in the title bar and the cursor moves to the next position. Pressing **↵** toggles between the upper and lower case keyboards, **⬅** backspaces, and **✖** deletes entered characters. You can use up to 31 characters including spaces in your title.

Special characters can be created using **^** and a capital letter; for example, **^J** for NL (New Line), **^M** for CR (Carriage Return). Special characters are commonly used by text input devices and will be useful when performing Text-In Searches.

## System Information

1. Highlight **Information** and press **←**. The Information screen (*Figure 3-6*) appears.

**Figure 3-6 Information Screen**

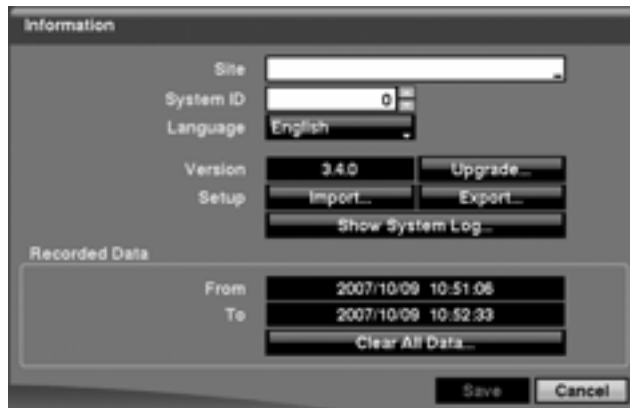

In the Information screen, you can: name the site location, assign a System ID number, select the language the screens are displayed in, display the software version number, upgrade the software, show the System Log, display recorded time data, and clear all data.

2. Highlight the **Site** box and press **↵**. A virtual keyboard appears that you can use to enter a Site Name.
3. Once you have entered your title, highlight **OK** and press **↵**.
4. Highlight the box beside **System ID** and press **↵**. Change the number by highlighting it and using the **Up** and **Down** arrow buttons to increase and decrease the number from 0 to 99.

---

**Note** The System ID number is used to identify the unit when it is connected with other DVRs through the RS485 port. You cannot use the same ID number for two or more DVRs that are in the same RS485 network. It is possible to have multiple DVRs with System ID 0 that are in the same area as long as they are not part of an RS485 network. If this is the case, all will be controlled at the same time when using the infrared remote control.

---

5. Highlight the box beside **Language** and press **↵**. A drop-down menu displays the available languages. Highlight the desired language and press **↵**.
6. The box beside **Version** displays the software version of the DVR. To upgrade the software:
  - a. Connect a USB device containing the upgrade package file to the DVR.
  - b. Highlight **Upgrade...** and press **↵**. The Upgrade screen appears. The screen displays the upgrade package file names that are available. The **.rui** indicates that the file is for software upgrades.
  - c. Select the desired file and press **↵**.
  - d. Highlighting **Install** and pressing **↵** will install the selected software package. Highlighting **Cancel** and pressing **↵** will close the window without upgrading the software.

If the upgrade package file is not installed on the DVR properly, you will get an error message.
  - e. The system restarts automatically after completing the upgrade.

**Figure 3-7 Upgrade Screen**

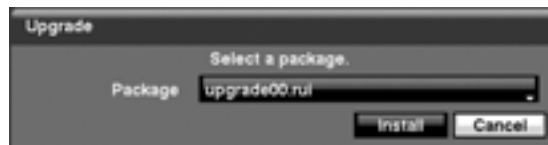

---

**Note** **Upgrade** will be deactivated if the hard disk drive has not been formatted as it requires the space for temporary files when upgrading the system.

---



---

**Caution** The USB device must be FAT16 or FAT32 format.

---

7. You can import saved DVR settings or export the current DVR settings. To import saved DVR settings:
  - a. Connect the USB device containing the setup file (.dat) to the DVR.
  - b. Highlight **Setup – Import...** and press **↵**.
  - c. Select the desired setup file and press **Import** to import the selected settings and change the DVR settings accordingly.
  - d. Highlight **Include Network Setup** and press **↵** to toggle between **On** and **Off**. When set to **Off**, the network settings will not be changed.

**Figure 3-8 Setup Import Screen**



8. To export the current DVR settings:
  - a. Connect the USB device to the DVR.
  - b. Highlight **Setup – Export...** and press **↵**.
  - c. Highlight the box beside **File name** and press **↵**. A virtual keyboard allows you to enter the file name.
  - d. Selecting **Export** will save the current settings in .dat file format on the USB device.

**Figure 3-9 Setup Export Screen**



---

**Note** Even after changing the DVR settings by importing saved settings, the time-related settings (Date/Time, Time Zone and Daylight Saving Time) will NOT be changed.

---

---

**Caution** The USB device must be FAT16 or FAT32 format.

---

9. Highlight **Show System Log...** and press **↵** to display the System Log.

**Figure 3-10 System Log Screen**

Time	Type
2006/10/24 16:03:16	Setup Begin
2006/10/24 16:03:16	Login : admin
2006/10/24 16:02:58	Archive On
2006/10/24 16:02:53	Boot Up
2006/10/24 16:02:29	Shutdown
2006/10/24 16:02:10	Logout : admin
2006/10/24 16:02:10	Setup End
2006/10/24 16:02:08	Setup Begin
2006/10/24 16:02:06	Setup End
2006/10/24 15:53:36	Archive On

The System Log screen lists system activities (up to 5,000 from the latest activity) that have occurred along with the time and date. The  icon will be displayed in the last column for system activities of the remote site. You can scroll through the log pages by using the Up and Down arrows, or you can go directly to a log page by entering the log page number in the box at the bottom-left of the screen. Highlight **Close** and press **↵** to exit the screen.

10. The box beside **Recorded Data – From / To** displays the time information of recorded data.
11. Highlighting **Clear All Data...** and pressing **↵** will clear all video data. You will be asked to verify that you wish to clear all data before the DVR erases the video data. **Clear All Data...** will not clear the System Log.
12. After you are finished with the Information Screen, you can highlight **Save** and press **↵** to save the changes and exit the screen. If you do not wish to save the changes, highlight **Cancel** and press **↵** to exit the screen.

## Date/Time Setup

1. Highlight **Date/Time** in the System menu and press **↵**. The Date/Time setup screen (*Figure 3-11*) appears.

**Figure 3-11 Date/Time Setup Screen**

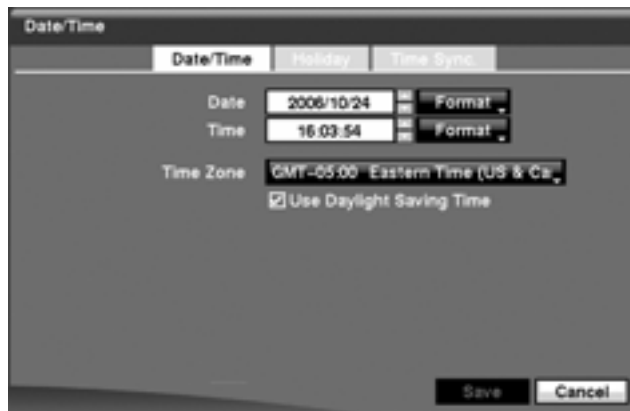

2. Highlight the first box beside **Date** and press **←**. The individual sections of the date will highlight. Use the **Up** and **Down** arrow buttons to change the number. Use the **Left** and **Right** arrow buttons to move between month, date and year. Once you have the correct date, press **←**.
3. Highlight the **Format** box beside **Date** and press **←**. Select from the three available date formats and press **←** to save your selected format.
4. Highlight the first box beside **Time** and press **←**. The individual sections of the time will highlight. Use the **Up** and **Down** arrow buttons to change the number. Use the **Left** and **Right** arrow buttons to move between hour, minutes and seconds. Once you have the correct time, press **←**.
5. Highlight the **Format** box beside **Time** and press **←**. Select from the three available time formats and press **←** to save your selected format.

---

**Note** The clock will not start running until you have highlighted **Save** and pressed **←**.

---

6. Highlight the box beside **Time Zone** and press **←**. Select your time zone from the list and press **←**.
7. Highlight **Use Daylight Saving Time** and press **←**. Pressing **←** toggles between **On** and **Off**.
8. Highlight the **Holiday** tab, and the Holiday setup screen (*Figure 3-12*) appears.

**Figure 3-12 Holiday Setup Screen**



9. You can set up holidays by highlighting + and pressing **←**. The current date appears.
10. Highlight the month and day and change them by using the **Up** and **Down** arrow buttons. Press **←** to add the date. Dates can be deleted by highlighting **X** beside the date and pressing **←**.

---

**Note** Holidays that do not fall on the same date each year should be updated once the current year's holiday has passed.

---

11. Highlighting the **Time Sync** tab causes the Time Sync screen to display. You can set up time synchronization between the DVR and standard time servers that are available in most time zones and countries, or between the DVR and another DVR.

**Figure 3-13 Time Sync. Screen**



12. Highlight the box beside **Automatic Sync** and press **←**. This toggles between **On** and **Off**.
13. Highlight the box beside **Time Server** and press **←**. A virtual keyboard appears that you can use to enter the IP address or domain name of the time server.

---

**Note** You can use the domain name instead of an IP address if you already set up the DVRNS Server when setting up the LAN.

---

14. Highlight the box beside **Interval** and press **←**. Set the time interval for synchronization from 30 minutes to 1 day at various time intervals.  
**Last Sync-Time** displays the last time the DVR was synchronized with the time server.
15. Highlight **Run as Server** and press **←**. Pressing **←** toggles between **On** and **Off**. When it is **On**, the DVR you are setting up will run as a time server.
16. You can save your changes by highlighting **Save** and pressing **←**. Selecting **Cancel** exits the screen without saving the changes.

## Storage Screen

1. Highlight **Storage** in the System menu and press **←**. The Storage setup screen (*Figure 3-14*) appears and displays information about the DVR's storage devices.

**Figure 3-14 Storage Information Screen**

Type	Capacity	Format	Information
Internal 1	74.71 GB	Record	In Use
Internal 2	74.71 GB	Archive	In Use

The information in the **Type** column describes the storage device.

The capacity of the storage device is displayed in the **Capacity** column.

The **Format** column displays whether the device is used for recording (**Record**) or archiving (**Archive**). **Not Using** indicates the device is not used for either recording or archiving. **Not formatted** indicates the device is not formatted.  indicates when the device has temporary space set aside so that video clips can be saved on a CD-RW or DVD-RW.

2. Highlight the box in the **Format** column for the desired storage device and press **←**. You will be able to format the device for recording or archiving. When selecting **Not Using** from **Use As** and highlighting **Format**, the device will not be used for either recording or archiving. You can also set aside space to store temporary files for CD or DVD burning by selecting **Partition – CD/DVD Burn**.

**Figure 3-15 Device Format Screen**

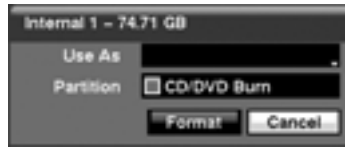

---

**Note** A USB hard disk drive can be formatted and used only for archiving.

---

---

**Note** The DVR does NOT support USB hard disk drives with a version lower than 2.0.

---

---

**Note** System upgrades require formatting internal hard disk drives, so do not uninstall internal hard disk drives even though they are not used for either recording or archiving; for example, when using only external SCSI hard disk drives. Set the **Use As** for the internal hard disk drive to **Not Using** and format it.

---

The **Information** column displays whether the device is being used or not. **Other** indicates the device has been used for another DVR.

3. Highlight the box in the **Information** column for the desired storage device and press **←**. You will be able to check the time information about recorded data.

**Figure 3-16 Device Information Screen**

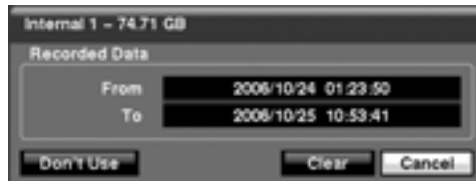

4. If you want to erase recorded data on the selected device, highlight **Clear** and press **←**. You will be asked whether or not you want to delete the data.
5. If you want to use a USB hard disk drive, highlight **Use** and press **←** after connecting the device. Highlight **Don't Use** and press **←** if you want to stop using the device.

---

**Note** When disconnecting a USB hard disk drive from the DVR, highlight **Don't Use** first and then disconnect the device.

---



---

**Caution** Do NOT disconnect the USB cable or the power from the device while copying video clips. If the USB cable is disconnected while copying video clips, archived data might be lost.

---

6. Highlight the **Status** tab, and the Storage Status screen (*Figure 3-17*) displays.

**Figure 3-17 Storage Status Screen**

Type	Disk Bad	Temperature	S.M.A.R.T.
Internal 1	Good (0%)	Good (38°C)	Good
Internal 2	Good (0%)	Good (38°C)	Good

The **Type** column displays the type of storage device.

The **Disk Bad** column displays the percentage of bad sectors. **Not formatted** indicates the device is not formatted.

The **Temperature** column displays the temperature of the storage device.

The **S.M.A.R.T.** column displays **Good**, **Bad** or **N/A**, depending on storage conditions.

- **Good** - The storage condition is normal.
- **Bad** - Data cannot be written on or read from the storage device.
- **N/A** - Storage conditions are normal, however, the S.M.A.R.T. monitoring is not working or supported.

---

**Note** When the storage condition is Bad, the Event Status - Storage screen displays and you can check the storage condition for details. Once the Bad message displays, replacing the hard disk drive is recommended, usually within 24 hours.

---

---

**Note** **Temperature** and **S.M.A.R.T.** information will be available only for IDE hard disk drives supporting the SMART (Self-Monitoring Analysis and Reporting Technology) monitoring program.

---

7. Selecting **Close** and pressing **←** exits the screen.

## User Setup Screen

1. Highlight **User** in the System menu and press **←**. The User setup screen (*Figure 3-18*) displays the authorized groups and users. You can add and delete groups and users. When adding a group, you can assign authority levels to the group.

**Figure 3-18** User Setup Screen



2. The +/- column is used to collapse and expand user groups. If there is a + or - in this column, it indicates the item is a Group Name. If there is a - in front of the Group Name, it indicates that the group has been expanded and all of the User Names within that group are displayed below the Group Name. If there is a + in front of the Group Name, it indicates that the group has been collapsed and all of the User Names within that group are hidden. To collapse or expand a group, highlight the +/- column in front of the desired group and press **←**.
3. Highlighting a **Group Name** and pressing **←** allows you to change the authority levels assigned to the group.

---

**Caution** Write down the new password and save it in a secure place. If the password is forgotten, the unit must be reset using the **Factory Reset** button and all data settings will be lost.

---



4. Highlighting a **User Name** and pressing **←** allows you to add or change the password assigned to that user. You can also change the group to which the user is assigned.
5. The **✖** column can be used to delete a **User Name** or an entire **Group**. If the **✖** is grayed out, that Group or User cannot be deleted. Highlight the **✖** and press **←**. You will be asked to confirm that you want to delete the User or Group. To delete the User currently logged into the DVR on a local system or a PC running RAS, log the user out of the system first and then delete the user.
6. To add a Group, highlight the **+ Group...** box and press **←**. A virtual keyboard appears allowing you to enter the Group name. You can use up to 15 characters including spaces in the group name. Enter the name and assign authority levels to the new group.

**Figure 3-19 New Group Setup Screen**



7. Highlighting the **Authority** box and pressing **←** will toggle between all authority levels being turned **On** and **Off**. Highlighting the individual authority level boxes and pressing **←** will toggle between that authority level being turned **On** and **Off**. The authority levels that can be turned **On** and **Off** are:
  - **Shutdown** — The user can shut the system down on a local system.
  - **Upgrade** — The user can upgrade the software on a local system or a PC running RAS.
  - **System Time Change** — The user can change the system date and time on a local system or a PC running RAS.
  - **Data Clear** — The user can clear all video data or format disks on a local system or a PC running RAS.
  - **Setup** — The user without Setup authority cannot establish any system settings excluding system shutdown and logout on a local system or a PC running RAS.
  - **Color Control** — The user can control brightness, contrast, hue and saturation for cameras on a local system or a PC running RAS.
  - **PTZ Control** — The user can control the PTZ camera on a local system or a PC running RAS.
  - **Alarm-Out Control** — The user can reset the DVR's outputs including the internal buzzer during an alarm by pressing **ALARM** on a local system or alarm-out control button on a PC running RAS.
  - **Covert Camera View** — The user can view video from cameras set as Covert while in the Live Monitoring or Search mode on a local system or a PC running RAS.

- **System Check** — The user can view the remote system status or check the remote system status as a batch process on a PC running RAS.
  - **Record Setup** — The user can establish all Record settings on a local system or a PC running RAS.
  - **Search** — The user can access Search mode on a local system or a PC running RAS.
  - **Clip-Copy** — The user can copy video clips on a local system or a PC running RAS, and save video data in an AVI, bitmap or JPEG file format.
8. To add a User, highlight the + **User...** box and press **←**. A virtual keyboard appears allowing you to enter the User Name. Enter the name and assign the User to a Group and password. You can use camera buttons 1 to 9 on either the front panel or remote control to assign the password. The password can be up to 8 digits. You will be asked to confirm the password.

**Figure 3-20 New User Setup Screen**



---

**Note** In addition to using the front panel buttons or the infrared remote control, you can use the virtual keyboard to assign the password. To display the virtual keyboard select the ... button using the mouse (not supplied) or the front panel arrow buttons.

---

9. Highlighting the box beside **Auto Login** allows you to select a User to be automatically logged in when the DVR is powered up. It can also be set to never automatically log in a user.
10. Highlighting the box beside **Auto Logout** allows you to select from a list of times that the user will be automatically logged out. The options are: Never, 1 min, 3 min, 5 min, 10 min, 15 min, 20 min, 25 min, 30 min and 1 hr.
11. You can save your changes by highlighting **Save** and pressing **←**. Selecting **Cancel** exits the screen without saving the changes.

## Shutdown Screen

Highlight **Shutdown** in the System menu and press **←**. The Shutdown screen (*Figure 3-21*) displays, asking you to confirm whether or not you want to shut the system down.

**Figure 3-21 Shutdown Screen**

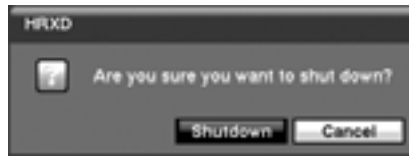

After selecting **Shutdown** and pressing **↵**, a screen will appear telling you when it is safe to disconnect power.

## Logout Screen

Highlight **Logout** in the System menu and press **↵**. The Logout screen displays asking you to confirm whether or not you want to log out the current user.

**Figure 3-22 Logout Screen**

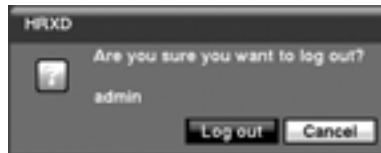

After selecting **Logout** and pressing **↵**, the user will be logged out.

---

## Network and Notification Setup

---

In the Main screen, use the Left or Right arrow buttons to display the Network menu.

**Figure 3-23 Network Menu**



## Network Screen

1. Highlight **Network** in the Network menu and press **↵**. The Network setup screen (*Figure 3-24*) displays. You will be able to change the Network, LAN, Modem, DVRNS and WebGuard settings.

**Figure 3-24 Network Setup Screen**



2. Highlight the first box beside **Transfer Speed**. Press the **Up** and **Down** arrow buttons to set the Transfer Speed from 50 Kbps to 100 Mbps.
3. Highlight the second box beside **Transfer Speed**. You can select the unit of measure for the transfer speed between: **bps** and **ips**. Press **←** to set the transfer speed.
4. Highlight the box beside **Quality** and press **←**. You can select the Quality from: **Very High, High, Standard** and **Low**. Press **←** to set the Quality.

---

**Note** The higher Quality settings require higher Transfer Speed settings. The transfer speed you set is the maximum speed. Depending on the network environment, this speed may not be achieved.

---

---

**Note** The local recording speed might be affected by various network bandwidth (Transfer Speed) conditions.

---

## LAN Setup Screen

1. Highlight the **LAN** tab, and the LAN screen (*Figure 3-25*) displays.

**Figure 3-25 LAN (Manual) Setup Screen**



2. Highlight the box beside **Type** and press **←**. You can select the type of network configuration from: **Manual**, **DHCP** and **ADSL** (with **PPPoE**). Select the desired type and press **←**.
3. Selecting **Manual** as the Type allows you to set up LAN parameters manually.

---

**Note** You will need to get the appropriate IP Address, Gateway and Subnet Mask values from your network administrator.

---

- a. Change the numbers by highlighting them and using the **Up** and **Down** arrow buttons to increase or decrease the number.

The factory default LAN settings are:

IP Address:	192.168.1.129
Gateway:	192.168.1.254
Subnet Mask:	255.255.255.0

- b. Highlight the box beside **DNS Server**. Press the **Up** and **Down** arrow buttons to set the IP address of the DNS server.
- c. Highlight the **Port Number Setup...** box and press **←**. The Port Number Setup screen (*Figure 3-26*) appears.

---

**Note** You will need to get the appropriate Port Numbers for each RAS and WebGuard related program (Admin, Callback, Watch and Search) from your network administrator.

---

**Figure 3-26 Port Numbers Setup Screen**



- d. Change the numbers by highlighting them and using the **Up** and **Down** arrow buttons to increase or decrease the number.

The factory default Port settings are:

Remote Admin:	8200
Remote Callback:	8201
Remote Watch:	8016
Remote Search:	10019

---

**Note** The system restarts automatically after changing the port settings.

---

---

**Note** Do NOT use the same port number for two different programs, otherwise, the DVR cannot be connected with the PC running RAS or WebGuard.

---

---

**Caution** When changing the port settings, you must change the port settings on the PC running RAS or WebGuard as well. Refer to the *RAS Plus User Manual* for details.

---

- 4. Selecting **DHCP** from the Type and highlighting **Save** reads the current IP address of the DVR configured by DHCP (Dynamic Host Configuration Protocol) network.

**Figure 3-27 LAN (DHCP) Setup Screen**



5. Selecting **ADSL (with PPPoE)** allows you to set up the ADSL network.

---

**Note** ADSL and modem cannot be configured at the same time. If the DVR is configured by modem, the **ADSL (with PPPoE)** will not be selected.

---

**Figure 3-28 LAN (ADSL) Setup Screen**



- a. Highlight the box beside **ID** and press **↵**. A virtual keyboard appears allowing you to enter the ID for ADSL connection.
- b. Highlight the box beside **Password** and press **↵**. A virtual keyboard appears allowing you to enter the password for ADSL connection.

---

**Note** Entering the **ID** and **Password** and highlighting **OK** reads the current IP address of the DVR configured by the ADSL network.

---

---

**Note** If the DVR is configured for DHCP or an ADSL network, the DVR's IP address might change whenever the unit is turned on.

---

## Modem Setup

1. Highlight the **Modem** tab, and the Modem screen (*Figure 3-29*) displays.

**Figure 3-29** Modem Setup Screen



---

**Note** If the RS232 port is in use for remote control, networking cannot be configured for a modem.

---

2. Highlight **Enable** and press **↵** to toggle between **On** and **Off**. You will only be able to change the settings if Modem is enabled.
3. Highlight the box beside **Baud Rate** and press **↵**. A list of baud rates ranging from 300 to 115,200 appears.
4. Highlight the box beside **Data Bit** and press **↵**. Choose between 7 bit and 8 bit formats.
5. Highlight the box beside **Stop Bit** and press **↵**. Choose between 1 and 2 Stop Bits.
6. Highlight the box beside **Parity** and press **↵**. A drop-down list appears. You can select from **None**, **Odd** or **Even** parity.



## DVRNS Setup

1. Highlight the **DVRNS** tab, and the DVRNS screen (*Figure 3-30*) displays.

**Figure 3-30** DVRNS Setup Screen



---

**Note** When LAN settings have been changed, set up the DVRNS after saving your LAN changes by highlighting **Save** and pressing **↵**.

---

2. Highlight **Use DVR Name Service** and press **↵** to toggle between **On** and **Off**.

---

**Note** The DVRNS (DVR Name Service) allows the DVR to use Dynamic IP addresses for remote connection. When this feature is **On**, you can access your DVR remotely using the DVR name instead of its IP address. For the DVRNS feature, the DVR should be registered on the DVRNS server.

---

3. Highlight the box beside **DVRNS Server** and press **↵**. A virtual keyboard appears allowing you to enter the IP address or domain name of the DVRNS server.

---

**Note** You will need to get the IP Address or domain name of the DVRNS Server from your network administrator.

---

---

**Note** You can use the domain name instead of IP address if you already set up the DNS Server when setting up the LAN.

---

4. Highlight the box beside **Port** and press **←**. Set the port number of the DVRNS server using the **Up** and **Down** arrow buttons to increase or decrease the numbers.
5. Highlight **Use NAT** and press **←** to toggle between **On** and **Off**.

---

**Note** When using the NAT (Network Address Translation) device, refer to the NAT manufacturer's instructions for the proper network settings.

---

6. Highlight the box beside **DVR Name** and press **←**. A virtual keyboard appears allowing you to enter the DVR name to be registered on the DVRNS server.
7. Highlight the **Check** box and press **←** to check whether or not the name you entered can be used.

---

**Note** The DVR name you entered should be checked by selecting **Check**, otherwise the DVRNS changes will not be saved.

---

---

**Note** When entering no name or a name already registered on the DVRNS server, an error message displays.

---

8. Highlighting **Save** and pressing **←** registers the DVR on the DVRNS server. Proper DVRNS settings will display the help desk information of the DVRNS server in the box beside **Help Desk**.

## WebGuard Setup

1. Highlight the **WebGuard** tab, and the WebGuard screen (*Figure 3-31*) displays.

**Figure 3-31 WebGuard Setup Screen**



2. Highlight **Use WebGuard Service** and press **↵** to toggle between **On** and **Off**. See *Appendix D, WebGuard* for detailed descriptions of the WebGuard service.
3. Highlight the box beside **Port** and press **↵**. Set the port number used when accessing WebGuard by using the **Up** and **Down** arrow buttons to increase or decrease the numbers.
4. You can save your Network changes by highlighting **Save** and pressing **↵**. Selecting **Cancel** exits the screen without saving the changes.

## Notification Setup

The DVR can be set up to send an e-mail or to contact a computer running RAS (Remote Administration System) when an event occurs.

1. Highlight **Notification** in the Network menu and press **↵**. The Notification screen (*Figure 3-32*) displays. You will be able to change the Mail and Callback settings.

**Figure 3-32 Notification Mail Setup Screen**



2. Highlight **Enable** and press **↵** to toggle between **On** and **Off**. You will only be able to change the settings if Mail is enabled.

3. Highlight the box beside **SMTP Server** and press **←**. Use the virtual keyboard that appears to enter the IP address or domain name of the SMTP server.

---

**Note** You will need to get the IP address or domain name of the SMTP Server from your network administrator.

---

---

**Note** You can use the domain name instead of IP address if you already set up the DNS Server when setting up the LAN.

---

4. Highlight the box beside **Port** and press **←**. Use the arrow buttons to enter the SMTP Server port number obtained from your network administrator. The default port number is 25.
5. Highlight **Use SSL/TLS** and press **←** to toggle between **On** and **Off**. When it is On, the DVR can send an e-mail via an SMTP server requiring SSL (Secure Sockets Layer) authentication.
6. Highlight the box beside **Authentication** and press **←**. An Authentication screen (*Figure 3-33*) appears.
  - a. Highlight **Use** and press **←** to toggle between **On** and **Off**.
  - b. Highlight the box beside **User/Password** and press **←**. A virtual keyboard appears allowing you to enter the user ID and password.
  - c. Highlight **OK** and press **←** to accept your changes.

**Figure 3-33 Authentication Setup Screen**



7. Highlight the box beside **Sender** and use the virtual keyboard to enter the sender's e-mail address.

---

**Note** The e-mail address must include the @ character to be a valid address.

---

8. Highlight the box beside **Recipient** and use the virtual keyboard to enter the recipient's e-mail address.
9. Highlight the **Callback** tab, and the Callback screen (*Figure 3-34*) displays.

**Figure 3-34 Notification Callback Setup Screen**



10. Highlight **LAN** and press **←** to toggle between **On** and **Off**. When LAN is turned On you can change the IP addresses.
11. Highlight the **IP Address** box that you want to change and press **←**. Enter the IP address of the computer you want contacted during an event. You can enter up to five IP addresses.
12. Highlight the box beside **Retry** and enter the number of times you would like the DVR to try contacting the computer(s). You can select from 1 to 10 retries.
13. If the modem was enabled in the Network screen, you can set up the DVR to contact a computer running RAS. Highlight **Modem** and press **←** to toggle between **On** and **Off**. When Modem is turned **On** you can enter a telephone number.
14. Highlight the box beside **Remote Server Phone Number** and enter the telephone number of the computer running RAS.
15. Highlight the box beside **Outside Line Call** and enter any numbers that must be dialed for an outside line to function on your telephone system; for example, **9**.
16. Highlight the box beside **Callback Phone Number** and enter the telephone number of the DVR.
17. You can save your Notification changes by highlighting **Save** and pressing **←**. Selecting **Cancel** exits the screen without saving the changes.

---

## Configuring Devices

---

You can configure the video, audio, alarm, display and remote control devices connected to the DVR.

**Figure 3-35 Device Menu**



## Camera Setup Screen

1. Highlight **Camera** in the **Devices** menu and press **←**. The Camera setup screen (*Figure 3-36*) appears.

**Figure 3-36 Camera Setup Screen**

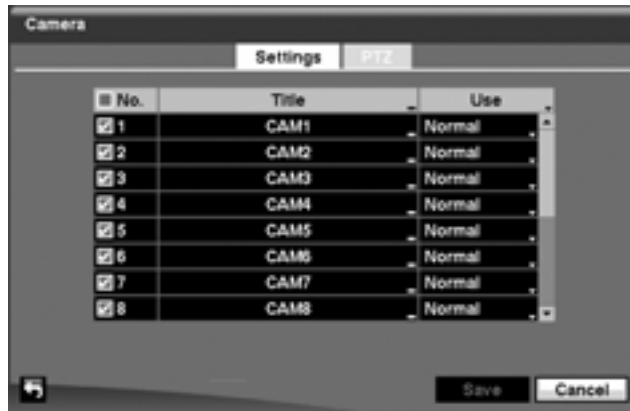

2. You can turn the camera number On or Off, and you can change the Title of each camera using the virtual keyboard.
3. You can also determine which cameras will display on the monitors by selecting **Normal**, **Covert 1** or **Covert 2** from a drop-down list in the **Use** column.

---

**Note** When selecting **Covert 1**, the DVR displays the camera title and status icons on the covert video. When selecting **Covert 2**, the DVR displays only the camera title on the covert video.

---

---

**Note** A user who does not have **Covert Camera View** authority cannot view video from cameras set to **Covert 1** or **Covert 2** in both the live monitoring and playback modes.

---

4. Highlight the **PTZ** tab, and the PTZ setup screen (*Figure 3-37*) displays.

**Figure 3-37 Camera PTZ Setup Screen**



---

**Note** You will only be able to set up PTZ devices if the PTZ port is set to RS232 or RS485. You will not be able to use a modem if you are using the RS232 port for PTZ control.

---

5. Highlight the box in the **Product** column for the PTZ camera you wish to configure and press **←**. A list of PTZ devices appears.
6. Select your camera from the list and press **←**. You will need to connect the camera to the RS232 or RS485 connector on the back of the DVR following the camera manufacturer's instructions.

**Figure 3-38 PTZ Device List**



7. You can assign IDs to each camera by highlighting the box under the **ID** heading and pressing **←**. Change the number by highlighting it and using the **Up** and **Down** arrow buttons to increase and decrease the number. The PTZ ID number can be set from 0 to 256.
8. Highlight the **Setup...** box and press **←**. The Port Setup window appears.

**Figure 3-39 Port Setup Window**



9. Configure the port's setting based on the PTZ camera manufacturer's instructions.
10. You can save your Camera changes by highlighting **Save** and pressing **←**. Selecting **Cancel** exits the screen without saving the changes.

## Audio Setup Screen

1. Highlight **Audio** in the Devices menu and press **←**. The Audio setup screen (*Figure 3-40*) appears.

**Figure 3-40 Audio Setup Screen**



2. The DVR can record up to four audio inputs. Highlight the box beside the input and press **←**. A list of cameras appears, and you can select which camera you want associated with that audio input.
3. Highlight **Enable Audio-Out** and press **←**. This toggles between enabling and disabling audio out.

---

**Note** The DVR will NOT record audio when the recording speed is set to less than 1 ips.

---

4. You can save your Audio changes by highlighting **Save** and pressing **←**. Selecting **Cancel** exits the screen without saving the changes.



## Alarm-Out Screen

1. Highlight **Alarm-Out** in the Devices menu and press  $\leftarrow$ . The Alarm-Out screen (*Figure 3-41*) allows you to change the settings and establish a schedule for each alarm output from the DVR.

**Figure 3-41 Alarm-Out Settings Screen**



2. Each alarm output can be given its own title by highlighting the box under the **Title** heading and pressing  $\leftarrow$ . A virtual keyboard appears allowing you to enter the title.
3. Highlighting the boxes under the **Type** heading allows you to set the alarm output for NO or NC (normally open or normally closed).
4. Highlighting the box beside **Dwell Time** and pressing  $\leftarrow$  allows you to set the dwell time of the alarm output. Dwell times range from 5 seconds to 15 minutes.
5. Highlighting the **Schedule** tab causes the Schedule screen (*Figure 3-42*) to display.

**Figure 3-42 Alarm-Out Schedule Screen**



6. You can add and edit alarm output schedules on this screen. Highlight the + and press  $\leftarrow$  to add a schedule. Highlighting the boxes in the columns and pressing  $\leftarrow$  allows you to edit the information in those boxes.









- a. The **Day** box allows you to select the days that the alarm schedule will be active. The choices are: Sun, Mon, Tue, Wed, Thu, Fri, Sat, M~F, Hol and All.
  - b. The **Range** box allows you to set the time that the alarm schedule will be active in 15-minute increments from 00:00 to 24:00.
  - c. The **Mode** box allows you to set how the alarm reacts during the scheduled time. When set to **On**, the Alarm-Out is active during the scheduled time. When set to **Event**, the Alarm-Out is only active when there is an Event during the scheduled time.
  - d. The **Channels** box allows you to set which alarm outputs will be active. You can also select the DVR's internal buzzer.
  - e. The  box allows you to delete an alarm output schedule. You will be asked to confirm whether or not you really wish to delete the schedule.
7. You can save your Alarm-Out changes by highlighting **Save** and pressing **↵**. Selecting **Cancel** exits the screen without saving the changes.

## Display Screen

1. Highlight **Display** in the Devices menu and press **↵**. The Display screen (*Figure 3-43*) allows you to select what information will be displayed on the monitor.

**Figure 3-43** Display OSD Screen



2. Highlighting an item and pressing **↵** toggles that item **On** and **Off**. When an item is **On**, there is a checkmark in the box beside it. The following items can be turned On or Off:
  - **Remote Control** — The icon  displays when the DVR can be controlled by the infrared remote control.
  - **Zoom** — The icon  displays on the enlarged video.
  - **Network** — The icon  displays when the unit is connected to a network via either Ethernet or modem.
  - **Freeze** and **Sequence** — The icon  displays while in Freeze mode, and the  displays while in Sequence mode.
  - **Screen Group** — The number of the screen group displays when the DVR is not in the 4x4 display mode of the 16-channel DVR, and 3x3 mode of the 9-channel DVR.
  - **Free Space** — The icon  displays when the DVR is in Recycle mode, and the percentage of available storage space displays when the DVR is not in Recycle mode.
  - **Archive** — The icon  displays when the DVR is archiving recorded data.
  - **Date/Time** — The current date and time information displays.
  - **User Name** — The name of the current user logged in displays.
  - **Camera No.** — The camera number displays at the top-left corner of each camera screen.
  - **Camera Title** — The camera title displays at the top-left corner of each camera screen.
  - **Record** — The record related icons display on each camera screen.
  - **PTZ** — The icon  displays on each PTZ camera screen.
  - **Text-In** — The text input strings display on the screen. You can adjust the **Display Dwell** time (in seconds) for the text input strings displayed on the screen.
3. You can adjust the transparency of the setup screens by highlighting **Transparency** and using the **Left** and **Right** arrow buttons.
4. Highlighting **OSD Margin...** and pressing **↵** displays how OSD text will be displayed on the monitor. You can adjust the horizontal and vertical margins so that text and icons will not be hidden beyond the edges of the monitor.

**Figure 3-44** OSD Margin Screen



5. Highlight the **Main Monitor** tab to switch to the Sequence screen (*Figure 3-45*).

**Figure 3-45 Main Monitor Screen**



6. Here you can adjust the display dwell time for each camera displayed in sequence on the main monitor. Highlight the box beside **Mode** and press **←**. You can select between **Full Sequence** and **Cameo Sequence**.

Pressing **SEQUENCE** causes the DVR to sequence cameras, and the DVR can sequence cameras in two modes: **Full** and **Cameo**. In the Full mode, the DVR sequences through the cameras and displays them full screen. In the Cameo mode, the bottom-right window in a multi-screen format sequences through the cameras.

---

**Note** Any cameras that are Off, have lost video or are set to Covert (unless the user has authority to view covert cameras) will be excluded from the Cameo sequence.

---

You can define the screen layout in a variety of formats and set the DVR to sequence through the different screen layouts (pages) so that all the cameras will be displayed. You can also set up the DVR to display one camera or a group of cameras all the time while cycling through the remaining cameras in a **Cameo** window. This can be done with one camera displayed full screen while displaying the cameo window as a PIP (picture in picture), or displaying the cameras in a grid pattern with the bottom-right window as the cameo.

---

**Note** Sequence cannot be used in the 4x4 display mode of the 16-channel, and the 3x3 mode of the 9-channel DVR.

---

7. You can adjust the display dwell time by highlighting the box beside **Interval** and pressing **←**. You can select dwell intervals ranging from 1 second to 1 minute.
8. Highlight **Event Monitoring On** and press **←**. Pressing **←** toggles between **On** and **Off**. When it is **On**, the DVR will display the camera associated with the event when an event occurs.
9. Highlight the **Spot Monitor** tab to switch to the Spot Monitor screen (*Figure 3-46*).

**Figure 3-46 Spot Monitor Screen**



10. You can define which cameras display sequentially on the Spot Monitors. Highlight the box in the **Channels** column for the desired Spot Monitor and press **←**.
11. You can save your Display settings by highlighting **Save** and pressing **←**. Selecting **Cancel** exits the screen without saving the changes.

## Remote Control Screen

1. Highlight **Remote Control** in the Devices menu and press **←**. The Remote Control setup screen (*Figure 3-47*) allows you to select a port and make correct settings for a remote keyboard.

**Figure 3-47 Remote Control Setup Screen**



2. Highlight the box beside **Port** and select from **None**, **RS232** and **RS485**. If the RS232 port and RS485 port are in use for PTZ control, networking or text input, the remote keyboard cannot be configured.
3. Highlight **Setup...** and select the correct Baud Rate, Parity, Data Bits and Stop Bits for the device you are connecting to the DVR.

## Configuration

4. Highlight the box beside **Remote Control Product** and select the device from the list.
5. You can save your Remote Control settings by highlighting **Save** and pressing **↵**. Selecting **Cancel** exits the screen without saving the changes.

---

## Recording Settings

---

Your DVR offers a variety of flexible recording modes. You can set it up to record all the time or to only record events. It can be set up to continue recording once the hard disk drive is full by recording over the oldest video, or you can set it up to alert you when the hard disk is full and stop recording.

**Figure 3-48 Record Menu**



## Record Screen

1. Highlight **Record** in the Record menu and press **↵**. The Record setup screen (*Figure 3-49*) appears.

**Figure 3-49 Record Setup Screen**



2. Highlighting **Recycle** and pressing **←** toggles between **On** and **Off**. In the Recycle mode, the DVR records over the oldest video data once all available storage space has been used. When Recycle is turned off, the DVR stops recording once all available storage space has been used.
3. Highlight the **Resolution** box and select from **High** and **Standard**. All other variables being equal; selecting High resolution will decrease the recording and playback speed by half that of Standard resolution.
4. Highlight the **Event Record Dwell** box and set the length of time you would like to record for the associated event. You can set the dwell from 5 seconds to 15 minutes. Refer to *Event Settings, page 75*, for more information regarding event recording.
5. Highlight the slide bar beside **Auto Deletion**, and use the **Left** and **Right** arrow buttons to adjust the length of time recorded data will be kept from 1 to 99 days. The DVR automatically deletes video recorded earlier than the user-defined period under three conditions: at midnight, whenever the system reboots or whenever the user changes the Auto Deletion settings. Selecting **Never** will disable the Auto Deletion function.
6. Highlighting **Use Panic Recording** and pressing **←** toggles between **On** and **Off**.
7. Highlight the **Panic Recording - Duration** box and set the duration of panic recording. Panic recording will stop automatically after the preset duration as long as the **PANIC** button is not pressed to stop the panic recording. You can set the dwell from 5 minutes to 1 hour. Select **No Limit** if you only want to stop panic recording manually.
8. Highlighting the **Panic Recording - ips** and pressing **←** allows you to set the images per second for Panic recording. You can select from **0.10** to **30.00** images per second.
9. Highlighting the **Panic Recording - Quality** and pressing **←** allows you to set the recorded image quality for Panic recording. You can select from: **Very High, High, Standard** and **Low**.
10. You can save your Record settings by highlighting **Save** and pressing **←**. Selecting **Cancel** exits the screen without saving the changes.

## Schedule Screen

1. Highlight **Schedule** in the Record menu and press **←**, and the Schedule setup screen (*Figure 3-50*) appears.

**Figure 3-50 Schedule Setup Screen**



You can program the DVR to record only during certain times based on time of day, day of the week, and holidays. The smallest time segment you can use is 15 minutes.

2. Highlighting **Schedule On** and pressing toggles between **On** and **Off**. In the Schedule On mode, the DVR records video based on the schedule(s) established in the Schedule screen. When turning Schedule recording Off, you will be asked to confirm your decision, and displays at the top-left corner of each camera screen. Panic recording will function even when Schedule is turned off. displays during panic recording.
3. Highlight the + and press to add a schedule item.
4. Highlight the box under the **Day** heading and press to change the days that the scheduled recording will take place. Choose from: **Sun, Mon, Tue, Wed, Thu, Fri, Sat, M~F, Hol** and **All**.
5. Highlight the box under the **Range** heading and press to change the time range that the scheduled recording will take place. The smallest time segment you can use is 15 minutes.
6. Highlight the box under the **Mode** heading and press to change the recording mode that will be used. Choose from: **No Record, Time, Event** and **Time & Event**.

When the DVR is in **No Record** mode, it will not record during the preset day and time range as long as the **PANIC** button is not pressed. Use the **No Record** mode when you do NOT want the DVR to record during certain times.

When the DVR is in **Time** mode, the icon displays at the top-left corner of the screen. The DVR will record and displays the icon at the top-left corner of the screen during the scheduled times.

When the DVR is in **Event** mode, the red icon displays at the top-left corner of the screen. The DVR will record and displays the icon at the top-left corner of the screen when any event occurs. When the DVR is in **Pre-Event** recording mode, the yellow icon displays when there is no event, and the DVR is not recording. When the DVR is in **Pre-Event** mode, the red and display when any event occurs and the DVR starts recording.

When the DVR is in **Time & Event** mode, the DVR will follow the Time settings and the icon displays. The DVR follows the Event settings and the displays.



7. Highlight the box under the **Channels** heading and press **←** to select which cameras will be recorded.
8. Highlight the box under the **Settings** heading and press **←** to define the recording settings. You can set the ips and Quality of the recording for any modes you set up in the **Mode** column. If you do not set the ips and Quality in the Settings column, the DVR will follow the default settings. See *Figure 3-51* for details.
9. Highlight the box under the **■** heading and press **←** to delete the recording settings. You will be asked to confirm that you want to delete the settings.
10. Highlight **Default...** and press **←**. The Default screen appears.

**Figure 3-51 Default Setup Screen**



11. Highlighting boxes under **ips** and pressing **←** allows you to set the images per second for Time and Event recording. You can select from **0.10** to **30.00** images per second.
12. Highlighting boxes under **Quality** and pressing **←** allows you to set the recorded image quality for Time and Event recording. You can select from: **Very High, High, Standard** and **Low**.
13. You can save your changes by highlighting **Save** and pressing **←**. Selecting **Cancel** exits the screen without saving the changes.

## Pre-Event Screen

1. Highlight **Pre-Event** in the Record menu and press **←**, and the Pre-Event setup screen (*Figure 3-52*) appears. If you do not have Event set up in the Record Schedule, a message will display alerting you to this fact.

**Figure 3-52 Pre-Event Setup Screen**



When the DVR is in the Event Record mode it is possible to have it record images before the event occurs. The **Pre-Event** screen allows you to define how to handle pre-event recording.

2. You can turn individual cameras On or Off for pre-event recording. The image speed can be set from **0.10** to **30.00** ips (25.00 ips PAL), and image quality can be selectable from **Very High, High, Standard** and **Low**.
3. You can set the amount of time to record prior to the event by adjusting the **Dwell**. You can set the **Dwell** from 5 seconds to 30 minutes. The longer the dwell set, the fewer maximum ips can be set.

---

**Note** When the DVR is in the Time or Time & Event mode, it ignores the pre-event settings and follows the time settings.

---

4. You can save your changes by highlighting **Save** and pressing **←**. Selecting **Cancel** exits the screen without saving the changes.

## Archive Screen

1. Highlight **Archive** in the Record menu and press **←**, and the Archive setup screen (*Figure 3-53*) appears.

**Figure 3-53** Archive Setup Screen



2. Highlight **Archive On** and press **←** to toggle between **On** and **Off**.

---

**Note** If you have not set up a storage device for archiving, a message appears notifying you of this.

---

3. Select the Days and Time Range you want archived.

4. You can accept the Archive Data Range by leaving the default checkmarks in the **Last Archived** and **Continue** boxes. If you wish to enter specific times and dates in **From** and **To**, toggle the checkmarks Off and then enter the time and date.
5. Highlight **Recycle** and press **←** to toggle between **On** and **Off**. When Recycle is **On** and the storage device is full, the newest archived video data will overwrite the oldest archived data. When Recycle is **Off**, the DVR will stop archiving video data until more space is made available.
6. Highlight **Summary Archive** and press **←** to toggle between **On** and **Off**. When Summary Archive is **On**, the DVR does not archive recorded video in full, but archives one image per 16 images from each channel. This will allow the DVR to archive more recorded video and increase archive speed as well.

---

**Note** The archiving speed might be slower than the recording speed when a large quantity of recorded data is being archived. In this case, the old data can be overwritten by the latest data being recorded. To prevent unwanted data overwriting please use the Summary Archive function, or set the recorded image quality to Standard during the archiving process.

---

7. You can save your changes by highlighting **Save** and pressing **←**. Selecting **Cancel** exits the screen without saving the changes.

---

## Event Settings

---

Your DVR can be set to detect many different events. You can also determine how it reacts to these events.

**Figure 3-54** Event Menu

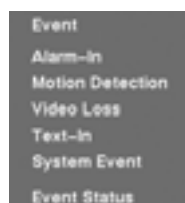

## Alarm-In Screen

1. Highlight **Alarm-In** in the Event menu and press **←**. The Alarm-In setup screen (*Figure 3-55*) appears.

**Figure 3-55 Alarm-In Settings Screen**



2. The alarm terminal strip on the back of the DVR has inputs associated with each alarm. You can set up each input on the **Alarm-In** screen. You can turn each input On or Off by highlighting the alarm number and pressing **←**.
3. Each input can be given a title. Highlight the desired **Title** box and press **←**. A virtual keyboard appears allowing you to enter a title name.
4. Each input can be set as **NO** (normally open) or **NC** (normally closed).
5. You can set the DVR to start panic recording whenever it senses an input on one of its alarm input connectors. Highlight the box beside **Panic Record** and press **←**. A list of Alarm Inputs appears, allowing you to select which alarm input you want associated with panic recording. The DVR will continue panic recording until an input on the selected alarm input is released, as long as the **PANIC** button is not pressed to stop the panic recording.
6. Highlight the **Actions 1** and **Actions 2** tabs, and the Actions 1 (*Figure 3-56*) and Actions 2 (*Figure 3-58*) setup screens appear.

**Figure 3-56 Alarm-In Actions 1 Screen**



You can set the actions the DVR will take whenever it senses an input on one of its alarm input connectors.

7. Highlight the desired box under the **Record** heading, and press **←**. A list of cameras appears. Select the cameras that you want the DVR to record whenever it detects an input on the associated alarm input.

---

**Note** For the Record action, the camera you select should be set to the Event or Time & Event recording mode in the Record Schedule setup screen.

---

8. Highlight the desired box under the **Alarm-Out** heading, and press **←**. A list of Alarm Outputs and **Beep** appear. Select the Alarm Output connectors that you would like to activate whenever the DVR detects an input on the associated alarm input. You can also set the DVR's internal buzzer to sound.

---

**Note** For the Alarm-Out action, the alarm output and beep you select should be set to the Event mode in the Alarm-Out setup screen, Schedule tab (see *Alarm-Out Screen, page 65*).

---

9. Highlight the desired box under the **Notify** heading, and press **←**. The Alarm-In Notify menu (*Figure 3-57*) appears.

**Figure 3-57 Alarm-In Notify Menu**

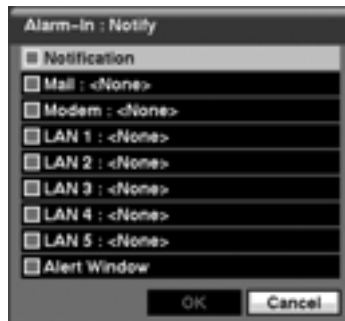

10. You can toggle the entire list On and Off by highlighting **Notification** and pressing **←**. You can toggle the individual items On and Off by highlighting that item and pressing **←**. Highlight **OK** and press **←** to accept your changes.

---

**Note** For the Notify action, the notify item you select should be enabled in the Notification setup screen and the DVR should be registered in the RAS (Remote Administration System).

---

**Figure 3-58 Alarm-In Actions 2 Screen**



11. In the **Actions 2** tab, highlight the desired box under the **PTZ** heading, and press **←**. A list of PTZ presets appears. Select the preset position for each PTZ camera, where you want PTZ cameras to move to whenever the DVR detects an input on the associated alarm input.
12. Highlight the desired box under the **Spot Monitor** heading, and press **←**. A list of SPOT monitors and cameras appears. Each SPOT monitor can be associated with a camera. The DVR will display the associated camera on the SPOT monitor whenever it detects an input on the associated alarm input.
13. You can save your Alarm-In changes by highlighting **Save** and pressing **←**. Selecting **Cancel** exits the screen without saving the changes.

## Motion Detection Screen

1. Highlight **Motion Detection** in the Event menu and press **←**. The Motion Detection setup screen (*Figure 3-59*) appears.

**Figure 3-59 Motion Detection Settings Screen**

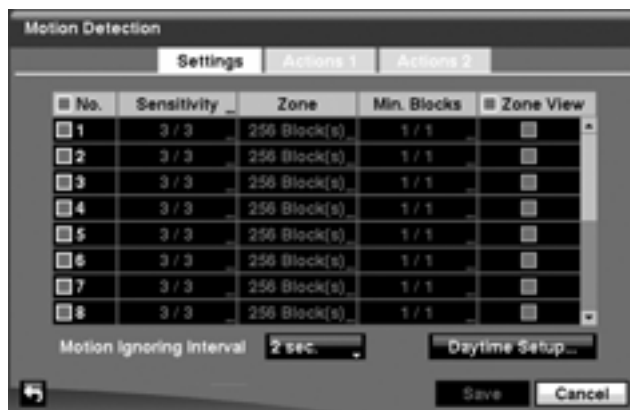

2. Your DVR has built-in video motion detection. Video motion detection can be turned On or Off for each camera by highlighting the motion detection number and pressing **←**.

3. Highlighting the box under the **Sensitivity** heading and pressing **←** allows you to adjust the DVR's sensitivity to motion for Daytime and Nighttime independently. There are five settings with **1** being the least sensitive and **5** being the most sensitive.

**Figure 3-60 Motion Detection Sensitivity Screen**

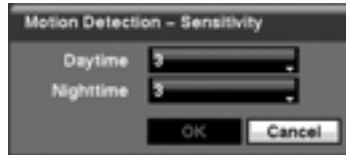

4. You can adjust the minimum number of detection blocks that must be activated to trigger a motion alarm. Highlighting the box under the **Min. Blocks** heading and pressing **←** allows you to adjust the minimum number of detection blocks for Daytime and Nighttime independently. Smaller numbers provide greater sensitivity because fewer detection blocks must be activated.

**Figure 3-61 Motion Detection Min. Blocks Screen**



5. Turning **Zone View On** will allow you to observe how the DVR is reacting to motion. When in the motion viewing mode, the detection zone of video will be displayed in green. Any detected motion within the zone will be displayed in red.
6. You can define the area of the image where you want to detect motion; for example, a doorway. Highlight the box under the **Zone** heading, and press **←**. The Motion Detection Zone screen (*Figure 3-62*) displays.

**Figure 3-62 Motion Detection Zone Screen**

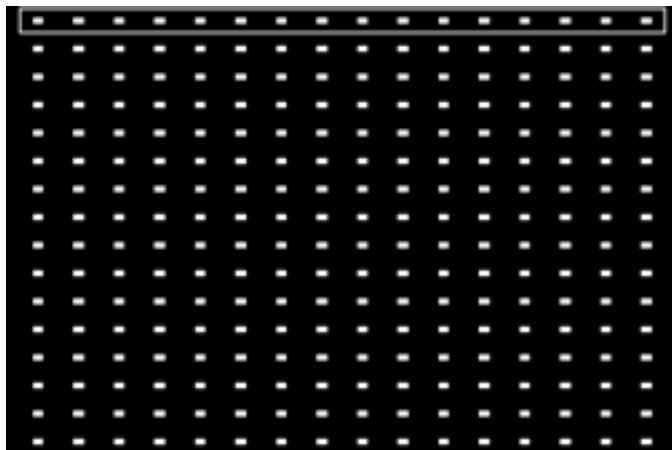

The Motion Detection Zone screen is laid over the video for the selected camera. You can set up motion detection zones by selecting or clearing blocks.

---

**Note** You can set up motion zones one block at a time in groups of 8 or 16 individual block groups (9- and 16-channel DVR respectively). A block group is positioned within the image area using the Up and Down arrow buttons, and individual blocks within the block groups are selected or cleared using the camera buttons.

---

7. Press **←** to display the menu screen. The menu on the setup screen has the following functions:

**Figure 3-63 Motion Detection Zone Menu**



- **Select** — Activates highlighted blocks to detect motion.
  - **Clear** — Deactivates highlighted blocks so that they will not detect motion.
  - **Reverse** — Activates inactive highlighted blocks and deactivates active highlighted blocks.
  - **Select All** — Activates all blocks to detect motion.
  - **Clear All** — Deactivates all blocks so that they will not detect motion.
  - **Reverse All** — Activates inactive blocks and deactivates active blocks.
  - **OK** — Accepts changes and closes Zone setup.
  - **Cancel** — Exits Zone setup without saving changes.
8. You can control excessive event logging and remote notification of motions detected after the motion dwell time by adjusting the motion ignoring dwell intervals. Highlight the box beside **Motion Ignoring Interval** and press **←**. A list of intervals ranging from **1** to **10** seconds or **Never** appears. The DVR will not log and notify motion events occurred during the preset interval range.

---

**Note** The record action for motion events will not be affected by the Motion Ignoring function.

---

9. Highlighting the box beside **Daytime Setup** and pressing **←** allows you to set up the Daytime range.

**Figure 3-64 Daytime Setup Screen**

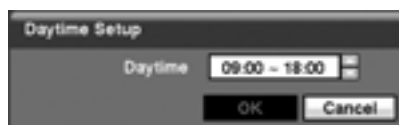



10. Highlight the box beside **Daytime** and press **←**. Use the **Up** and **Down** arrow buttons to set the Daytime range. The DVR will consider the remaining time range as the Nighttime.
11. Highlight the **Actions 1** and **Actions 2** tabs and the Motion Detection Actions 1 (*Figure 3-65*) and Actions 2 (*Figure 3-66*) screens display.

**Figure 3-65 Motion Detection Actions 1 Screen**



The DVR can be set to react to motion detection differently for each camera. Each camera can be associated with another camera, trigger an Alarm-Out connector, sound the DVR’s internal buzzer, notify a number of different devices, move PTZ cameras to preset positions, and/or display a camera on a SPOT monitor.

---

**Note** You can associate multiple cameras with a camera that detects motion.

---

12. Highlight the box under the **Record** heading and press **←**. A list of cameras appears. You can associate as many cameras with that camera as you wish. If the DVR detects motion on the selected camera, it starts recording video from all the associated cameras.

---

**Note** For the Record action, the camera you select should be set to the Event or Time & Event recording mode in the Record Schedule setup screen.

---

13. Highlight the box under the **Alarm-Out** heading and press **←**. A list of Alarm Outputs appears. You can associate as many Alarm-Outs with that camera as you wish. When the DVR detects motion on the selected camera’s input, it triggers output signals on all the associated Alarm-Out connectors. You can also have the DVR’s internal buzzer sound if motion is detected on the selected camera.

---

**Note** For the Alarm-Out action, the alarm output and beep you select should be set to the Event mode in the Alarm-Out setup screen, Schedule tab (see *Alarm-Out Screen, page 65*).

---

- Highlight the box under the **Notify** heading and press **←**. You can toggle the entire list On and Off by highlighting **Notification** and pressing **←**. You can toggle the individual items On and Off by highlighting that item and pressing **←**. Highlight **OK** and press **←** to accept your changes.

---

**Note** For the Notify action, the notify item you select should be enabled in the Notification setup screen and the DVR should be registered in the RAS (Remote Administration System).

---

**Figure 3-66 Motion Detection Actions 2 Screen**



- In the **Actions 2** tab, highlight the desired box under the **PTZ** heading, and press **←**. A list of PTZ presets appears. Select the preset position for each PTZ camera, where you want PTZ cameras to move to whenever the DVR detects motion on the selected camera's input.
- Highlight the desired box under the **Spot Monitor** heading, and press **←**. A list of SPOT monitors and cameras appears. Each SPOT monitor can be associated with a camera. The DVR will display the associated camera on the SPOT monitor whenever it detects motion on the selected camera.
- You can save your Motion Detection changes by highlighting **Save** and pressing **←**. Selecting **Cancel** exits the screen without saving the changes.

## Video Loss Screen

1. Highlight **Video Loss** in the Event menu and press **←**. The Video Loss setup screen (*Figure 3-67*) appears.

**Figure 3-67 Video Loss Settings Screen**



2. The DVR checks to see if anything is obscuring the camera. Highlight the slider bar beside **Check Obscuration**, and use the Left and Right arrow buttons to adjust the setting. The sensitivity can be set from **Never** to **255** (extremely sensitive).
3. Highlight the **Actions 1** and **Actions 2** tabs and the Video Loss Actions 1 and Actions 2 screens display.

**Figure 3-68 Video Loss Actions 1 Screen**



The DVR can be set to react to video loss differently for each camera. Each camera can be associated with another camera, trigger an Alarm-Out connector, sound the DVR's internal buzzer, notify a number of different devices, move PTZ cameras to preset positions, and/or display a camera on a SPOT monitor.

4. Highlight the box under the **Record** heading and press **←**. A list of cameras appears. You can associate as many cameras with that camera as you wish. If the DVR detects video loss on the selected camera, it starts recording video from all the associated cameras.

---

**Note** For the Record action, the camera you select should be set to the Event or Time & Event recording mode in the Record Schedule setup screen.

---

5. Highlight the box under the **Alarm-Out** heading and press **←**. A list of Alarm Outputs appears. You can associate as many Alarm-Outs with that camera as you wish. When the DVR detects video loss on the selected camera, it will trigger output signals on all the associated Alarm-Out connectors. You can also have the DVR's internal buzzer sound if video is lost on the selected camera.

---

**Note** For the Alarm-Out action, the alarm output and beep you select should be set to the Event mode in the Alarm-Out setup screen, Schedule tab (see *Alarm-Out Screen, page 65*).

---

6. Highlight the box under the **Notify** heading and press **←**. You can toggle the entire list On and Off by highlighting **Notification** and pressing **←**. You can toggle the individual items **On** and **Off** by highlighting that item and pressing **←**. Highlight **OK** and press **←** to accept your changes.

---

**Note** For the Notify action, the notify item you select should be enabled in the Notification setup screen and the DVR should be registered in the RAS (Remote Administration System).

---

**Figure 3-69 Video Loss Actions 2 Screen**

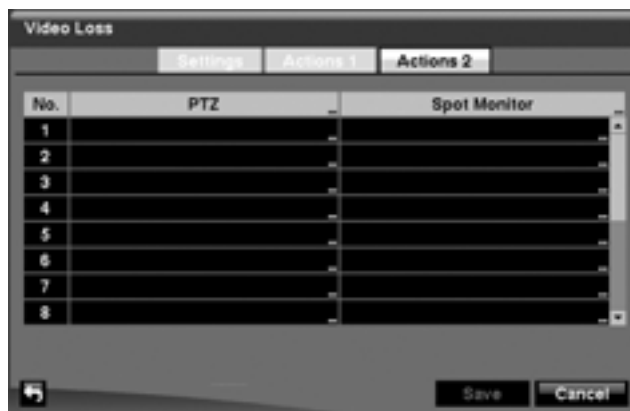

7. Highlight the desired box under the **PTZ** heading, and press **←**. A list of PTZ presets appears. Select the preset position for each PTZ camera, this is where you want PTZ cameras to move to when the DVR detects video loss on the selected camera's input.

8. Highlight the box under the **Spot Monitor** heading and press **←**. A list of SPOT monitors and cameras appears. Each SPOT monitor can be associated with a camera. The DVR will display the associated camera on the SPOT monitor whenever it detects video loss on the selected camera.
9. You can save your Video Loss changes by highlighting **Save** and pressing **←**. Selecting **Cancel** exits the screen without saving the changes.

## Text-In Screen

1. Highlight **Text-In** in the Event menu and press **←**. The Text-In setup screen (*Figure 3-70*) appears.

**Figure 3-70 Text-In Settings Screen**



The DVR can be setup to react to text input from devices such as ATMs (Automated Teller Machines) and POS (Point of Sale; as in cash registers). This screen allows you to configure the DVR for each text-in device.

2. Highlight the box under the **Setup** heading, and press **←**. Selecting the **Setup** heading changes all the parameters excluding Port settings of all the text input channels.

---

**Note** The system performance might be affected when a large quantity of text inputs are detected from several channels at the same time.

---



---

**Note** VP Filter, Generic Text and EPSON-POS devices are currently supported.

---

**Figure 3-71 Text-In Device (VP Filter) Settings Screen**

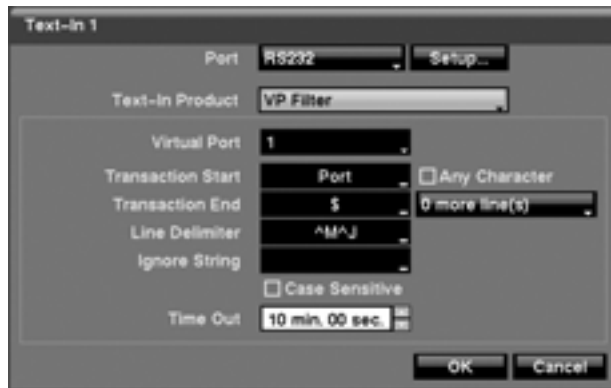

**Figure 3-72 Text-In Device (Generic Text and EPSON-POS) Settings Screen**

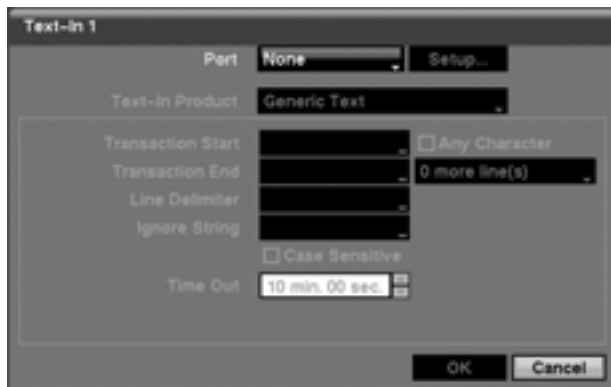

3. Highlight the box beside **Port**, and press **←**. Select from **None**, **RS232**, **RS485** and **USB-Serial (1~8)**.

---

**Note** If you have set the Port as **None**, you will not be able to make any changes to the screen.

---

---

**Note** When using the USB to serial text-in device, do NOT remove the USB cable from the port while the system is running.

---

4. Highlight **Setup...**, and press **←**. Use the ATM or POS manufacturer's recommended settings when configuring the RS232, RS485 or USB-Serial ports.
5. Highlight the box beside **Text-In Product**, and press **←**. Select your device from the list.

---

**Note** The screen changes for the different types of text input devices, changing the parameter boxes for you to enter information.

---

6. Highlight the box beside **Virtual Port**, and press **←**. Select the port number to use. This field will be activated only when setting up the **VP Filter** device.
7. Highlight the box beside **Transaction Start**, and press **←**. Use the virtual keyboard to enter the Transaction Start string. Refer to the device manufacturer's documentation for the text string that the device first sends when a transaction starts.
8. If you want the DVR to react to any character sent from the text input device, you will want to turn on **Any Character**. Highlight **Any Character**, and press **←** to toggle between On and Off.

---

**Note** If **Any Character** is turned On, you will not be able to enter any text in the **Transaction Start** box.

---

9. Highlight the box beside **Transaction End**, and press **←**. Use the virtual keyboard to enter the Transaction End string. Refer to the device manufacturer's documentation for the text string that the device sends when a transaction ends.
10. Highlight the **more line(s)** box, and press **←**. Select the number of additional lines of text that you want the DVR to record. You can choose from **0** to **10**.
11. Highlight the box beside **Line Delimiter**, and press **←**. Use the virtual keyboard to enter the character(s) that the device uses to indicate the end of a line. Special characters can be created using **^** and a capital letter; for example, **^J** for NL (New Line), **^M** for CR (Carriage Return). Refer to the device manufacturer's documentation for Line Delimiter character(s).
12. Highlight the box beside **Ignore String**, and press **←**. Use the virtual keyboard to enter any strings of text that you want the DVR to ignore. Refer to the device manufacturer's documentation for text strings that the device sends during transactions, so you will know which ones you do not want recorded.
13. Highlight the **Case Sensitive** box, and press **←** to toggle between **On** and **Off**. Refer to the device manufacturer's documentation to determine if the text strings are Case Sensitive. If the device distinguishes between upper and lower case letters, make certain the **Case Sensitive** box is enabled.
14. Highlight the box beside **Time Out**, and press **←**. Set the length of time to wait for the next text string. The DVR will consider a transaction ended if there is no text string during timeout dwell time after the last text input string. You can adjust Time Out dwell from 0 seconds to 10 minutes.
15. Highlight the **Actions 1** and **Actions 2** tabs and the Text-In Actions 1 and Actions 2 screens display.

**Figure 3-73 Text-In Actions 1 Screen**



The DVR can be set to react to text input. Text input can be associated with cameras, trigger an Alarm-Out connector, sound the DVR's internal buzzer, notify a number of different devices, move PTZ cameras to preset positions, and/or display a camera on a SPOT monitor.

- Highlight the box under the **Record** heading and press **←**. A list of cameras appears. You can associate as many cameras with the Text Input as you wish. If the DVR detects text input, it starts recording video from all the associated cameras.

---

**Note** For the Record action, the camera(s) you select should be set to the Event or Time & Event recording mode in the Record Schedule setup screen.

---

- Highlight the box under the **Alarm-Out** heading and press **←**. A list of Alarm Outputs appears. You can associate as many Alarm-Outs with the Text Input as you wish. When the DVR detects text input, it triggers output signals on all the associated Alarm-Out connectors. You can also have the DVR's internal buzzer sound if text input is detected.

---

**Note** For the Alarm-Out action, the alarm output and beep you select should be set to the Event mode in the Alarm-Out setup screen, Schedule tab (see [Alarm-Out Screen, page 65](#)).

---

- Highlight the box under the **Notify** heading and press **←**. You can toggle the entire list On and Off by highlighting **Notification** and pressing **←**. You can toggle the individual items On and Off by highlighting that item and pressing **←**. Highlight **OK** and press **←** to accept your changes.



---

**Note** For the Notify action, the notify item you select should be enabled in the Notification setup screen and the DVR should be registered in the RAS (Remote Administration System).

---

**Figure 3-74 Text-In Actions 2 Screen**



19. Highlight the desired box under the **PTZ** heading, and press **←**. A list of PTZ presets appears. Select the preset positions for each PTZ camera, this is where you want PTZ cameras to move to when the DVR detects text input.
20. Highlight the box under the **Spot Monitor** and press **←**. A list of SPOT monitors and cameras appears. Each SPOT monitor can be associated with a camera. The DVR will display the associated camera on the SPOT monitor whenever it detects an input on the selected text-in device.
21. You can save your Text-In changes by highlighting **Save** and pressing **←**. Selecting **Cancel** exits the screen without saving the changes.

## System Event Screen

1. Highlight **System Event** in the Event menu and press **←**. The System Event setup screen (*Figure 3-75*) appears.

**Figure 3-75 Health Check Screen**



The DVR can be configured to run self-diagnostics and report the results.

2. Highlighting the box beside **System** and pressing **←** allows you to select the interval that you want the DVR to run self-diagnostics on the system. You can select from **1 hr** to **30 days**, or **Never**.
3. Highlight the **Setup...** box beside **Check Recording** and press **←**. The Check Recording screen appears. Highlighting **Schedule On** and pressing **←** toggles the schedules On and Off. When set to On, you can select the day, time range and interval that you want the DVR to run self-diagnostics on the recorder. The **Interval** can be selectable from **1 min** to **7 days**, or **Never**. The **X** box allows you to delete a check recording schedule.

**Figure 3-76 Check Recording Screen**



4. Highlighting the box under the **Interval** heading beside each alarm-in and pressing **←** allows you to change the interval that you want the DVR to run self-diagnostics on Alarm Inputs. You can select from **1 hr** to **30 days** or **Never**.
5. Highlight the **Storage** tab and the Storage screen (*Figure 3-77*) displays.

**Figure 3-77 Storage Screen**



6. Highlight the box beside **Disk Bad Notify**, and press **←**. Select the percentage level of bad disk sectors at which point you want the DVR to trigger an alert. Percentage levels range from 10% to 90%.
7. Highlight the box beside **Disk Almost Full Notify**, and press **←**. Select the percentage level of disk usage at which point you want the DVR to trigger an alert. Percentage levels range from 80% to 99%.
8. Highlight the **Setup...** box beside **Disk S.M.A.R.T.**, and press **←**. The S.M.A.R.T. Setup screen (*Figure 3-78*) appears.

**Figure 3-78 S.M.A.R.T. Setup Screen**

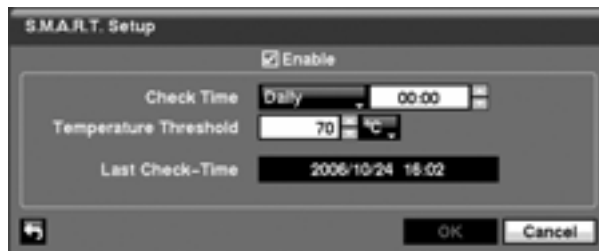

9. Highlight **Enable**, and press **←** to toggle S.M.A.R.T. Setup On and Off.

---

**Note** If **Enable** is turned Off, you will not be able to make changes to any of the other fields.

---

10. Highlight the box beside **Check Time**, and press **←**. You can select from **Monthly**, **Weekly** and **Daily**. If you select **Monthly**, you will be asked to set the Day of the Month and Time to perform the check. If you select **Weekly**, you will be asked to set the Day of the Week and Time. If you select **Daily**, you will be asked to set the Time.
11. Highlight the first box beside **Temperature Threshold**, and press **←**. Use the Up and Down arrow buttons to scroll through the numbers. Refer to the hard disk drive manufacturer's documentation for the correct temperature setting. If the temperature of the hard disk drive exceeds the defined threshold, the system triggers an alert.

12. Highlight the second box beside **Temperature Threshold**, and press **←**. Select either **°C (Celsius)** or **°F (Fahrenheit)**, and press **←**.

---

**Note** The box beside **Last Check-Time** displays the Date and Time of the last S.M.A.R.T. check.

---

13. Highlight **OK**, and press **←** to accept the changes. Selecting **Cancel** exits the screen without saving the changes.
14. Highlight the **Actions** tab and the System Event Actions screen (*Figure 3-79*) displays.

**Figure 3-79 System Event Actions Screen**



The DVR can be setup to react to system events. System events can be associated with an Alarm-Out connector, sound the DVR's internal buzzer, and/or notify a number of different devices.

15. Highlight the **Alarm-Out** box beside the desired event (**Check Recording**, **Check Alarm-In**, **Disk Almost Full**, **Disk Full**, **Disk Bad**, **Disk Temperature**, or **Disk S.M.A.R.T.**), and press **←**. A list of Alarm Outputs appears. You can associate as many Alarm-Outs with the Event as you wish. If the DVR detects that event, it triggers output signals on all the associated Alarm-Out connectors. You can also have the DVR's internal buzzer sound if an event is detected.

---

**Note** **Alarm-Out** action cannot be set to System and Panic Record events.

---

16. Highlight the **Notify** box beside the desired event and press **←**. You can toggle the entire list On and Off by highlighting **Notification** and pressing **←**. You can toggle the individual items On and Off by highlighting that item and pressing **←**. Highlight **OK** and press **←** to accept your changes.

---

**Note** Mail notify is the only option available for the **System** event.

---



---

**Note** For the Notify action to work, the DVR should be registered in the RAS (Remote Administration System).

---

17. You can save your System Event changes by highlighting **Save** and pressing **←**. Selecting **Cancel** exits the screen without saving the changes.

## Event Status Screen

Highlight **Event Status** in the Event menu and press **←**. The Event Status screen (*Figure 3-80*) appears.

**Figure 3-80** Event Status Screen



The Event Status screen displays the status of the DVR's systems and inputs. The following events will be highlighted, and related channels or events will flicker for five seconds when detected:

- **Alarm-In, Motion, Video Loss** and **Text-In** will be highlighted when each event is detected based on the settings you made in the Alarm-In, Motion Detection, Video Loss and Text-In setup screens on the Event menu.
- **Check Alarm-In** and **Check Recording** will be highlighted when each event is detected based on the settings you made in the System Event setup screen on the Event menu.
- **Panic Record** will be highlighted while the DVR is in the panic recording mode.

## Configuration

- **Disk Almost Full** will be highlighted when the DVR is not in the Recycle mode and the level of disk usage reaches the Disk Almost Full percentage you specified in the System Event setup screen on the Event menu. **Disk Full** will be highlighted when the DVR is not in the Recycle mode and all available storage space has been used.

Highlighting the **Storage** tab will display the hard disk drive status. Refer to *Storage Screen, page 45* for more details.

## Operation

---

**Note** This chapter assumes your DVR has been installed and configured. If it has not, please refer to *Chapter 2* and *Chapter 3*.

---

The DVR's controls are similar to a VCR. As with a VCR, the main functions are recording and playing back video. However, you have much greater control over recording and playing back video. You can establish recording schedules based on time of day and day of the week. The DVR allows you to search through the recorded video using much more sophisticated tools than those available with VCRs. Additional DVR features that are not available with VCRs are remote control and viewing, and recording video at the same time you are watching previously recorded video.

The front panel controls are described in *Chapter 3, Configuration*.

---

## Turning on the Power

---

Once you have installed the DVR following the instructions in *Chapter 2, Installation*, it is ready to record.

---

## Live Monitoring

---

As soon as the DVR completes its initialization process, it will begin showing live video on the attached monitor and playing live audio through the attached speaker. The default mode is to display all cameras at once. Pressing any camera button will cause that camera to display full screen. It displays live video and plays live audio until the user enters another mode.

Pressing **DISPLAY** cycles the DVR through the different display formats.

The DVR can be set to display full-screen video for a preset dwell time when an Event occurs. Video from the lowest camera number associated with the event sensor will be displayed, the DVR will return to the previous screen format after the event monitoring dwell time expires. While the event monitoring is activated, the monitoring for all other subsequent events will be ignored. Pressing individual camera buttons or the **DISPLAY** button during event monitoring releases the current event monitoring and displays the selected camera or returns to the previous screen format.

Pressing **SEQUENCE** causes the cameras to display sequentially. When in one of the multi-view formats, pressing this button will cause the DVR to go through predefined screen layouts (Full Sequence). Or, the bottom-right screen will display live cameras sequentially (Cameo Sequence). Selecting another display mode, or pressing **SEQUENCE** again exits the Sequence mode. When in one of the multi-view formats, pressing the Left or Right arrow buttons will cause the DVR to go to the previous or the next page. For example, if you press the Right arrow button in the 2x2 format, the DVR changes pages as follows:

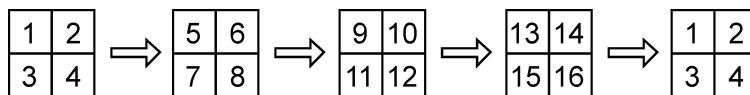

If all the cameras in a page are Off, have lost video or are set to Covert (unless the user has authority to view covert cameras), that page will be excluded from the sequence.

---

**Note** The **Full Sequence** for the full sequence monitoring and the **Cameo Sequence** for the cameo sequence monitoring should be selected in the Display setup screen, Sequence tab (see *Display Screen, page 66*).



---

Pressing **FREEZE** will freeze the current image on the screen until you press the button again. While in the Freeze mode, the icon  displays in bottom-left corner if **Freeze** is selected in the Display setup screen (OSD tab).

To display cameras sequentially on a spot monitor, press **SPOT** and select the Spot Monitor and Sequence from the menu.



## Active Cameo Mode



You can enter the Active Cameo mode by pressing  in any multi-view format. The yellow outline surrounding the video indicates the active cameo, and pressing the arrow buttons moves the active cameo. Pressing  while in the Active Cameo mode exits the Active Cameo mode. The active cameo mode will remain in effect for 15 seconds if there is no further operation.

In active cameo mode, press the button for the camera you want displayed as active cameo. After setting the camera number to active cameo, the DVR moves the active cameo to the next cameo. You can change the screen layout in this way.

## PIP Mode

You can display a Picture-in-Picture by pressing **DISPLAY**. You can change the location of the PIP counterclockwise and clockwise by pressing the **Up** and **Down** arrow buttons and change its size by turning the Jog Dial clockwise or counterclockwise.

## Zoom Mode

You can enlarge an area of the video by pressing **ZOOM**. For a few seconds after pressing **ZOOM**, a PIP displays. Inside the PIP, a rectangle shows the area that is enlarged. You can move the rectangle around using the arrow buttons. While in the Zoom mode, you can enlarge the area more by pressing . The Zoom mode options are 2x, 3x and 4x. Exit Zoom mode by pressing **ZOOM**. While in Zoom mode,  displays in bottom-left corner if **Zoom** is selected in the Display setup screen (OSD tab).





## PTZ Mode

If a user who has **PTZ Control** authority logs into the system, the user can control PTZ cameras. The DVR will control cameras with Pan, Tilt and Zoom capabilities. Press **PTZ** to enter PTZ mode and press the button again to exit PTZ mode. You can control the camera using front panel control buttons, by setting up presets or by selecting the expanded PTZ features.

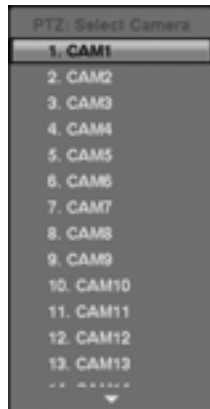
1. Select the PTZ camera you wish to control by selecting it from the menu. The icon  displays on the PTZ camera screen.

**Figure 4-1 PTZ Select Camera Menu**



2. Use the front panel buttons to control the PTZ. Press the **Left** and **Right** arrow buttons to pan left and right. Press the **Up** and **Down** arrow buttons to tilt the camera up and down. Press  to zoom in, and press  to zoom out. You can use  and  to focus the image.
3. You can establish preset positions for PTZ cameras. Press  to establish Presets.





**Figure 4-2 PTZ Set Preset Screen**



4. You can quickly move PTZ cameras to Preset positions. Press  to view an established camera Preset position.

**Figure 4-3 PTZ Preset View Screen**



5. You can save camera position settings as presets so that you can go directly to desired views.
  - a. Once you have the camera at the desired settings, press , and the PTZ Preset dialog box will appear.
  - b. Select the number you want to assign to the preset and press .
  - c. Use the virtual keyboard to enter the preset name.
  - d. Press  to load the PTZ preset and the Preset View dialog box will appear.
  - e. Select the desired preset and press .
6. Pressing **MENU** displays the following PTZ menu. Set the feature you wish to control by selecting it from the menu. Refer to the camera manufacturer's instructions for the proper settings. Depending on the camera specifications, some features may not be supported.

**Figure 4-4 PTZ Menu**

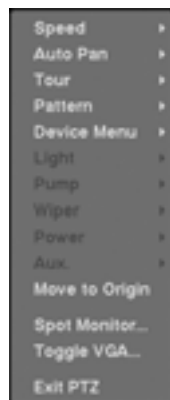









7. You can also use a mouse for convenient PTZ control. Position the mouse pointer at the bottom of the screen, and the following PTZ toolbar will display.

**Figure 4-5 PTZ Controls**



- Clicking  on the left side closes the toolbar. If you want to display the toolbar again, position the mouse pointer at the bottom of the screen. Change the toolbar location by clicking the empty space on the left side of the toolbar and drag it to where you want it located on the screen. Use the arrow buttons on the toolbar to pan or tilt the camera in the direction you want. The other controls on the toolbar perform as described below:

**Table 4-1 PTZ Controls**

		Zoom In/Out
		Focus Near/Far
		Iris Open/Close
		Set/Load Preset

## Image Adjustment

---

**Note** It is important that cameras and monitors are correctly installed and adjusted prior to making any image adjustments using the DVR's controls.

---

If a user who has **Color Control** authority logs in, the user can adjust the image. Pressing and holding a camera button for a few seconds displays an image adjustment dialog. You can control brightness, contrast, hue and saturation for each camera.

---

**Note** Any image adjustments you make will be applied to both the live video on the monitors and the recorded video.

---

---

## Event Monitoring

---

When an event occurs, the DVR will display the camera associated with the event if **Event Monitoring On** is selected in the Display setup screen, OSD tab (see *Display Screen, page 66*).

How the cameras are displayed depends on the number of cameras associated with the event. If one camera is associated with the event, the DVR will display the camera full screen. If two to four cameras are associated with the event, the DVR will display the cameras on a 2x2 screen. If five to nine cameras are associated with the event, the DVR will display the cameras on a 3x3 screen. If 10 or more cameras are associated with the event, the DVR will display the cameras on a 4x4 screen.

Event monitoring lasts for the dwell time set for event recording. After the dwell time has elapsed, the monitor returns to the previous screen unless another event has occurred. If you want to return to the live monitoring mode before the dwell time has elapsed, press **DISPLAY** or one of the camera buttons.

---

## Covert Camera

---

If a camera is set up as **Covert 1** in the Camera setup screen, Settings tab (see *Camera Setup Screen, page 62*), that camera will not be displayed unless a user with **Covert Camera View** authority logs into the system. However the camera title and status icons will be displayed on the monitor.

If a camera is set up as **Covert 2** in the Camera setup screen, Settings tab (see *Camera Setup Screen, page 62*), that camera appears to be Off unless a user with **Covert Camera View** authority logs into the system. The camera title will be grayed out and status icons will not be displayed on the monitor.

---

**Note** When a camera is set up as **Covert 1**, the DVR displays the camera title and status icons on the covert video. When set up as **Covert 2**, the DVR displays only the camera title on the video.

---

If a user who has **Covert Camera View** authority logs in, the user can view video from cameras set to **Covert 1** or **Covert 2** including the camera titles and status icons.

---

## Spot Monitoring

---

You can select the camera you want to display on a Spot Monitor:

1. Press **SPOT** on the front panel or remote control, then select one of four Spot Monitors.
2. Select the camera to be displayed on the Spot Monitor.

**Figure 4-6 Spot Monitor Menu**



If you want to display more than one camera on a Spot Monitor, you can display them sequentially:

1. In the Spot Monitor selection mode, press **SEQUENCE** on the front panel or remote control, or select **Sequence On** from the menu to start displaying cameras sequentially.
2. Press **SEQUENCE** or select **Sequence On** again to stop sequencing on the Spot Monitor.

Any cameras that are Off, have lost video or are set to **Covert** (unless the user has authority to view covert cameras) will be excluded from the sequence.

**Figure 4-7 Sequence Menu**



The Spot Monitor 1 supports multi-view formats and displays live video using the same settings as the main monitor.

When the Spot Monitor is in the sequence mode, you can set the camera's display dwell time. Refer to *Display Screen* on [page 66](#) for details.

---

## Using a Mouse

---

You can use a mouse instead of the front panel buttons to perform many of the DVR functions. The following operations are supported when using a mouse during live monitoring:

- When in one of the multi-view formats (for example, PIP, 2x2, 3x3 or 4x4), clicking the mouse button on a camera image switches that camera to full screen. Clicking the mouse button again returns to the previous multi-view format.
- When in one of the multi-view formats, scrolling the mouse wheel up and down operates the same as pressing **DISPLAY** by switching the screen format between PIP, 2x2, 3x3 and 4x4.
- Clicking the right mouse button during live monitoring displays *Figure 4-8*.

**Figure 4-8**      **Mouse Menu**



- Selecting **Freeze**, **PTZ...** and **Spot Monitor...** is the same as pressing the **FREEZE**, **PTZ** and **SPOT** buttons as described in the *Live Monitoring* section of this chapter.
- Selecting **Zoom...** zooms in on the live image. While in the zoom mode, there are two ways to move around the enlarged portion of the video. First, there is a PIP located in the bottom-right corner. The PIP has a rectangle showing what area of the image has been enlarged. Click inside the PIP to move to another area of the image you want enlarged. Second, click and hold the mouse button on the enlarged video and drag the video.
- Selecting **Toggle VGA** is the same as pressing and holding **DISPLAY** for more than five seconds. It switches the video output between Video Out (BNC or SVHS Out) and VGA Out. During clip copy, you cannot switch the output between Video Out and VGA Out.

---

**Caution**    The DVR will NOT record video for about 3 seconds while switching the video output between **Video Out** and **VGA Out**.

---

- Selecting **Display** shows *Figure 4-9*.

**Figure 4-9** Mouse Display Menu



- Clicking **Camera** and selecting the camera number is the same as pressing the individual camera buttons on the front panel which displays the selected camera full screen. When in the PIP display mode, clicking the right mouse button and selecting **PIP** changes the location and the size of the PIP.
- Selecting PIP, 2x2, 3x3 and 4x4 displays the cameras in the selected multi-view screen mode.
- Clicking **Previous Group** or **Next Group** is the same as pressing the Left or Right buttons on the front panel which moves to the previous or next page.
- Selecting **Edit Group** supports the active cameo function. Select **Edit Group** and choose a camera that you want to change the display position (for example, Camera A). Then, click the right mouse button to display the menu. If you select another camera in the menu (for example, Camera B), the screen displays Camera B instead of Camera A. When in the 4x4 format, Camera A and Camera B will switch positions.

---

## Recording Video

---

Once you have installed the DVR following the instructions in *Chapter 2, Installation*, it is ready to record. The DVR will start recording based on the settings you made in the **Record** setup screen (see *Chapter 3, Configuration*).

Recording can be set to **Recycle On** or **Recycle Off**. The factory default is **Recycle On**, which means the DVR records over the oldest video once the hard disk is full. Setting the DVR to **Recycle Off** causes it to stop recording once the hard disk is full.

Resolution can be set to **Standard** or **High**. The factory default resolution is **Standard**. When set to **Standard**, the DVR has a maximum recording speed of 240 ips. When set to **High**, the DVR has a maximum recording speed of 120 ips.

---

**Note** When the DVR is in the search mode, the maximum recording speed decreases by half. For example, in search mode, the DVR's maximum recording speed decreases to 120 ips when set to Standard resolution.

---



Pressing **PANIC** starts panic recording of all cameras, and pressing the button again stops panic recording. If you set the **Panic Recording Duration** in the Record Screen (see *Record Screen, page 70*), panic recording will stop automatically according to the preset duration as long as **PANIC** is not pressed.

---

**Note** When the DVR is not in Recycle mode and all available storage space has been used, panic recording will not operate.

---

Although you will be able to record without changing the unit from its original factory settings, you will want to take advantages of the DVR's many tools. See *Chapter 3, Configuration* for detailed descriptions of the recording options.

---

## Recording Audio

---

If the DVR was set up to record audio, it will record audio from up to four inputs when video is recording. The DVR will not record audio when the recording speed is set to less than 1 ips.

---

**Note** Make certain you comply with all local and federal laws and regulations when recording audio.

---

---

## Playing Recorded Video

---

If a user who has **Search** authority logs into the system, the user can view recorded images. Once video has been recorded, you can view it by pressing **PLAY/PAUSE**. When playing video for the first time, the DVR will display the most recent image. When playing video subsequent times, the DVR will start playing video from the last recalled image. Recorded audio will be played when the DVR displays a camera with recorded audio in full screen mode.

---

**Note** While playing back video, the recording speed might decrease.

---







---

**Note** Only the administrator and users with **Covert Camera View** authority can view video from covert cameras. The covert cameras in the playback mode are determined by the current camera settings.

---







Pressing **PLAY/PAUSE** again will freeze the video on the screen.

## RW (Rewind) Button

Pressing **RW** plays video backward at high speed. Pressing the button again toggles the playback speed between ,  and . The screen displays ,  and  respectively.

Entering Fast Backward Playback mode from Live Monitoring mode can be password protected.

## FF (Fast Forward) Button

Pressing **FF** plays video forward at high speed. Pressing the button again toggles the playback speed between ,  and . The screen displays ,  and  respectively.

Entering Fast Playback mode from Live Monitoring mode can be password protected.

## BACKWARD Button

Pressing **BACKWARD** goes to the previous image.

## FORWARD Button

Pressing **FORWARD** goes to the next image.

## SEARCH Button

Pressing **SEARCH** while in the Playback mode returns the DVR to the Live Monitoring mode. Pressing **SEARCH** while in the Live Monitoring mode returns the DVR to the Search mode.

## Camera Buttons (1 to 16)

Pressing a camera button will display that camera full screen.







## DISPLAY Button

Pressing **DISPLAY** will cycle the display through the different screen layouts. The display modes are: 4x4, PIP, 3x3 and 2x2 (not all formats are available for the 9-channel DVR).

## ZOOM Button

Pressing **ZOOM** zooms the current playback image on the screen.

## Shuttle Ring

The Shuttle Ring only functions in Playback mode. The Shuttle Ring is spring loaded and returns to the center position when released. Turning the ring clockwise plays video forward. Turning the ring counterclockwise plays video backward. Playback speed varies with the amount the ring is turned. The playback speeds are , , , , ,  and .

When you release the ring, it snaps back to the center position and the video pauses.

## Jog Dial

The Jog Dial only functions when playback video has been paused. By turning the jog dial clockwise, you can play video forward image-by-image. By turning the jog dial counterclockwise, you play video backward image-by-image.

You can also use a mouse for convenient playback control. Position the mouse pointer on the search screen, and the following search toolbar will display.







**Figure 4-10** Mouse Playback Controls



Clicking  on the left side exits the toolbar. If you want to display the toolbar again, position the mouse pointer on the screen. Change the toolbar location by clicking the empty space on the right side of the toolbar and drag it to where you want it located on the screen.

The individual controls on the toolbar perform the following functions as described below:

**Table 4-2** Mouse Playback Controls

	Go to the first image
	Fast backward play
	Go to the previous image
	Play
	Go to the next image
	Fast forward play
	Go to the last image

---

## Searching Video

---

Pressing **MENU** or clicking the right mouse button while in the Search mode displays the Search Menu (*Figure 4-11*).

---

**Note** While searching video, the recording speed might decrease.

---

**Figure 4-11 Search Menu**

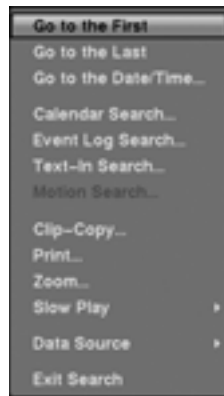

- **Go to the First** — Displays the first recorded image
- **Go to the Last** — Displays the last recorded image
- **Go to the Date/Time...** — Searches by date and time (see below for more details)
- **Calendar Search...** — Searches using a calendar (see below for more details)
- **Event Log Search...** — Selects video from the event log (see below for more details)
- **Text-In Search...** — Searches text input strings (see below for more details)
- **Motion Search...** — Searches motion events (see below for more details)
- **Clip-Copy...** — Clips a video segment and saves it (see below for more details)
- **Print...** — Allows you to print a selected image (see below for more details)
- **Zoom...** — Zooms the current playback image
- **Slow Play...** — Plays video at low speed (x1/2, x1/3, x1/4, x1/6 and x1/8)
- **Data Source** — Allows you to choose between recorded and archived video
- **Exit Search** — Exits the Search Menu

---

**Note** The searching speed might decrease when all camera channels are in the pre-alarm recording mode.

---

## Go to the Date/Time

**Figure 4-12 Go to the Date/Time Screen**

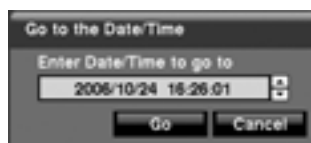

1. Move the cursor over the date and time and press **←**.

2. You can use the **Left** and **Right** arrow buttons to highlight the year, month, day, hours, minutes and seconds. Use the **Up** and **Down** arrow buttons to change to the date and time you want to search for video.
3. Once you have set the date and time you want, press **↵**. Then highlight **Go** and press **↵**.
4. Video from the selected date and time will display (if no video was recorded during the selected time, a message appears alerting you that no image was recorded at that time). The **PLAY/PAUSE**, **RW**, **FF**, Jog Dial and Shuttle Ring can now be used to review the surrounding video.

## Calendar Search

Figure 4-13 Calendar Search Screen



1. Days with recorded video display on the calendar with white numbers. You can highlight the days with recorded video by using the arrow buttons. Once you have highlighted a day, press **↵** to select it.
2. A time bar displays at the bottom of the calendar. Hours in which video was recorded will be highlighted with blue. Use the **Up** and **Down** arrow buttons to highlight the time bar.
3. Once the time bar is highlighted, select the time by using the **Left** and **Right** arrow buttons.

---

**Note** The time bar is in one-hour segments. If a segment is highlighted, it means that some video was recorded during that hour. However, it does NOT mean video was recorded for the entire hour.

---

4. If the DVR's time and date have been reset to a time that is earlier than some recorded video, it is possible for the DVR to have more than one video stream in the same time range. Move to **Select a Segment**, and select the video stream you want to search. Refer to *Appendix E, Time Overlap* for further information on searching time-overlapped video streams.

---

**Note** The lower number of the Segment indicates the latest recorded video.

---

5. Once you have set the date and time you want to search, highlight **GO** and press **←**. Video from the selected date and time will display. The **PLAY/PAUSE, RW, FF**, Jog Dial and Shuttle Ring can now be used to review the surrounding video.

---

**Note** It is possible that no recorded image displays on the current screen. Press **DISPLAY** and change the screen mode to 4x4. You will be able to easily see which camera(s) have recorded video during the target time.

---

## Event Log Search

Figure 4-14 Event Log Search Screen

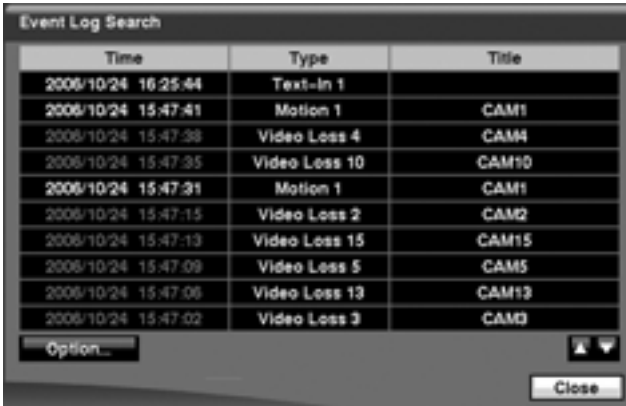

Time	Type	Title
2006/10/24 16:25:44	Text-In 1	
2006/10/24 15:47:41	Motion 1	CAM1
2006/10/24 15:47:39	Video Loss 4	CAM4
2006/10/24 15:47:35	Video Loss 10	CAM10
2006/10/24 15:47:31	Motion 1	CAM1
2006/10/24 15:47:15	Video Loss 2	CAM2
2006/10/24 15:47:13	Video Loss 15	CAM15
2006/10/24 15:47:09	Video Loss 5	CAM5
2006/10/24 15:47:06	Video Loss 13	CAM13
2006/10/24 15:47:02	Video Loss 3	CAM3

Option... [Close]

The DVR maintains a log of each time the Alarm Input port is activated. The Event Log Search screen displays this list.

The Event Log Search screen can also be accessed by pressing **ALARM** unless there is an alarm. There is no determined user authority to display the Event Log Search screen, however, the event video will not be played unless a user with **Search** authority logs into the system.

1. Use the arrow buttons to highlight the event for which you would like to see video.
2. Pressing **←** will extract the event video and display the first image of the event.
3. Pressing **PLAY/PAUSE** will start playing the event video segment. Pressing **SEARCH** returns to live monitoring.

---

**Note** It is possible that no recorded image displays on the current screen. Press **DISPLAY** and change the screen mode to 4x4. You will be able to easily see which camera(s) have recorded video during the target time.

---

4. You can also narrow your event search by selecting **Option...** and setting up a new search condition.

**Figure 4-15 Event Log Search Option Screen**



You can search video from the first to last recorded images, or you can set the start and stop times and dates.

- a. Highlight the box beside **From** and press **←** to toggle between **On** and **Off**. When set to **Off**, you can enter a specific Date and Time. When set to **On**, the search will be from the first recorded image.
- b. Highlight the box beside **To** and press **←** to toggle between **On** and **Off**. When set to **Off**, you can enter a specific Date and Time. When set to **On**, the search will be from the last recorded image.
- c. Highlight the box beside **Check Time Overlap** and press **←**. It toggles between **On** and **Off**. You will only be able to turn the Check Time Overlap on or off if a user-defined date and time is set for **From** and **To**. If the DVR's date and time have been reset, it is possible for the DVR to have more than one overlapping start and stop time. When set to **On**, you will be asked to select one of the overlapping start and stop times. When set to **Off**, the DVR will display search results from all start times to all stop times.
- d. Highlight the box beside **Alarm-In** and press **←**. You can select the alarm inputs that you want to include in your search.
- e. Highlight the box beside **Motion** and press **←**. You can select the cameras for which you want to search for any reports of motion detection.



- f. Highlight the box beside **Video Loss** and press **←**. You can select the cameras for which you want to search for any reports of lost video.
  - g. Highlight the box beside **Text-In** and press **←**. You can select the text-in devices for which you want to search for any report of text input.
  - h. Highlight the box beside **Record Channels** and press **←**. You can select the cameras that you want to search for any reports of event recorded data. The DVR will display the events (not the camera channels) that occurred and that also are recorded on the camera channel that you selected. If you do not select a camera channel in this field, the DVR will search events that are not associated with cameras.
  - i. You can also toggle On and Off self-diagnostic events as part of your search. The choices are:
    - Panic Record
    - Check Recording
    - Check Alarm-In
    - Disk Almost Full
    - Disk Bad
    - Disk Temperature
    - Disk S.M.A.R.T.
5. Once you set your desired search conditions, highlight **Search** and press **←** to display the search results in the **Event Log Search** screen. Selecting **Cancel** exits the screen without saving the changes.

## Text-In Search

**Figure 4-16 Text-In Search Screen**

Time		Transaction	
2006/10/24	16:30:16	abc Market	2003.01.01 AM 09:00
2006/10/24	16:30:15	abc Market	2003.01.01 AM 09:00
2006/10/24	16:30:15	abc Market	2003.01.01 AM 09:00
2006/10/24	16:30:14	abc Market	2003.01.01 AM 09:00
2006/10/24	16:30:14	abc Market	2003.01.01 AM 09:00
2006/10/24	16:30:13	abc Market	2003.01.01 AM 09:00
2006/10/24	16:30:13	abc Market	2003.01.01 AM 09:00
2006/10/24	16:30:12	abc Market	2003.01.01 AM 09:00
2006/10/24	16:30:12	abc Market	2003.01.01 AM 09:00
2006/10/24	16:30:11	abc Market	2003.01.01 AM 09:00

Option... [Close]

The DVR maintains a log of each time there is Text Input. The Text-In Search screen displays this list.

1. Use the arrow buttons to highlight the event for which you would like to see video.
2. Pressing **←** will extract the video associated with the Text Input and display the first image of the event.

3. Pressing **PLAY/PAUSE** will start playing the event video segment. Pressing **SEARCH** returns to live monitoring.

---

**Note** It is possible that no recorded image displays on the current screen. Press **DISPLAY** and change the screen mode to 4x4. You will be able to easily see which camera(s) have recorded video during the target time.

---



---

**Note** Text Input information will be overlaid on the image while the recorded video is played at regular speed.

---

4. You can also narrow your event search by selecting **Option...** and setting up a new search condition.

**Figure 4-17 Text-In Search Option Screen**



You can search video from the first to last recorded images, or you can set the start and stop times and dates.

- a. Highlight the box beside **From** and press **←** to toggle between On and Off. When set to Off, you can enter a specific Date and Time. When set to On, the search will be from the first recorded image.
- b. Highlight the box beside **To** and press **←** to toggle between On and Off. When set to Off, you can enter a specific Date and Time. When set to On, the search will be from the last recorded image.
- c. Highlight the **Channel** and press **←**. Select the text-in devices that you want to search for text input.
- d. Highlight the **Text Input Device** box and press **←**. Select your Text Input Device from the list.

- e. Highlighting **+** and pressing **←** allows you to add a new search parameter. Set up the desired search parameter. Refer to *Appendix B, Text In Search Examples* for more information on setting up search parameters. The **✕** column can be used to delete a single search parameter or all of the search parameters.
  - f. Highlight **Case Sensitive** and press **←**. This will toggle between On and Off. When this feature is On, the search will find only those text strings in which the case matches.
  - g. Highlight **Load** and press **←** to load saved search option settings. Select the desired search option setting.
  - h. Highlight **Save** and press **←** to save the current search option settings. Use the virtual keyboard that appears to enter the search option name.
5. Once you set your desired search conditions, highlight **Search** and press **←** to display the search results in the Text-In Search screen. Selecting **Cancel** exits the screen without saving the changes.

## Motion Search

**Figure 4-18 Motion Search Screen**

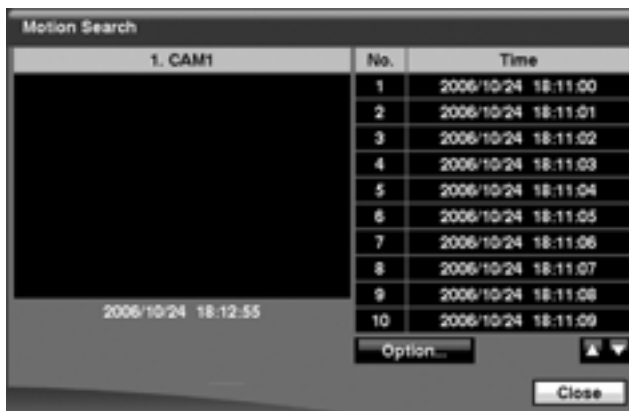

1. The **Motion Search...** can be selected from the Search menu while the DVR displays the camera full screen. The Motion Search screen displays a list of motion events.
2. Use the arrow buttons to highlight the event for which you would like to see video and press **←** to display the video associated with the selected event on the small search screen.
3. Highlighting **Close** and pressing **←** will extract the video associated with the Motion event and display the first image of the event.
4. Pressing **PLAY/PAUSE** will start playing the event video segment. Pressing **SEARCH** returns to live monitoring.
5. You can also narrow your event search by selecting **Option...** and setting up a new search condition.

**Figure 4-19 Motion Search Option Screen**

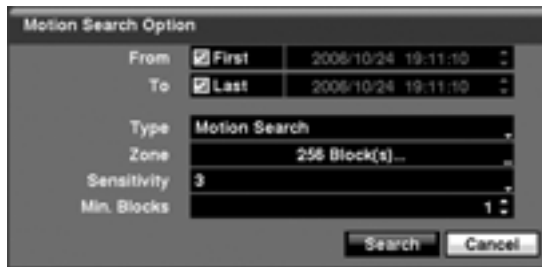

You can search video from the first to last recorded images, or you can set the start and stop times and dates.

- a. Highlight the box beside **From** and press  $\leftarrow$  to toggle between On and Off. When set to Off, you can enter a specific Date and Time. When set to On, the search will be from the first recorded image.
- b. Highlight the box beside **To** and press  $\leftarrow$  to toggle between On and Off. When set to Off, you can enter a specific Date and Time. When set to On, the search will be from the last recorded image.
- c. Highlight the box beside **Type** and press  $\leftarrow$ . You can select between **Motion Search** and **Museum Search**. **Motion Search** detects motion in the defined area. **Museum Search** detects if a defined object has moved.
- d. Highlight the box beside **Zone** and press  $\leftarrow$ . An image from the video appears with a grid overlaid. You can turn sensor blocks On and Off to define the area of the picture in which you want to search for motion.

---

**Note** Defining the area of the image in which you want to search for motion is nearly identical to setting up the DVR for Motion Detection. Please refer to *Motion Detection Screen* in *Chapter 3, Configuration* for more detailed instructions on setting up the detection blocks.

---



---

**Note** When setting the Museum Search Zone, the zone should be placed inside of the border line of the target object. If the selected block is placed on the border line, the sensitivity of the Museum Search may decrease.

---

- e. For Museum searching, the zone should be placed or focused on the center or, at least, within the outline of targeted object.
- f. Highlight the box beside **Sensitivity** and press  $\leftarrow$ . You will be able to select from **1** (low sensitivity) to **5** (high sensitivity).
- g. Highlight the box beside **Min. Blocks** and press  $\leftarrow$ . You will be able to set the number of sensor blocks that must be activated for motion to be detected. Setting the Min Blocks is only available if Motion Search is selected.

6. Once you set your desired search conditions, highlight **Search** and press **↵** to display the search results in the Motion Search screen. Selecting **Cancel** exits the screen without saving the changes.

When you search for motion events of another camera, you will be asked whether or not you want to delete the previous search results from the list.

## Clip-Copy Screen

The **Clip-Copy** screen can be used to copy video clips to an internal CD-RW or DVD-RW drive, or external USB hard disk, CD-RW or flash drive. The copied video clips can be viewed on computers running Microsoft Windows 98, ME, 2000 or XP. Refer to *Appendix A, USB Hard Disk Drive Preparation* for information on preparing the external drive for clips. The clip copy can be simply done by pressing **MENU** or **FREEZE**.

1. Press and hold **MENU** for more than two seconds while in the Search mode, and the Clip-Copy screen appears to allow clip copy setup.
2. Pressing **FREEZE** during the playback will set the starting point of the video to be clip copied, and  displays at the bottom-left corner of the screen.
3. Pressing **FREEZE** again will set the ending point of the video to be clip copied by displaying the Clip-Copy screen.
4. Pressing and holding **FREEZE** for more than two seconds while in Search mode or Live Monitoring mode initiates the One-Touch Clip Copy function. The last recorded image will be the ending point of video to be clip copied, and the system will automatically begin to calculate the possible video data size that the selected storage media can handle.

**Figure 4-20** Clip-Copy Screen

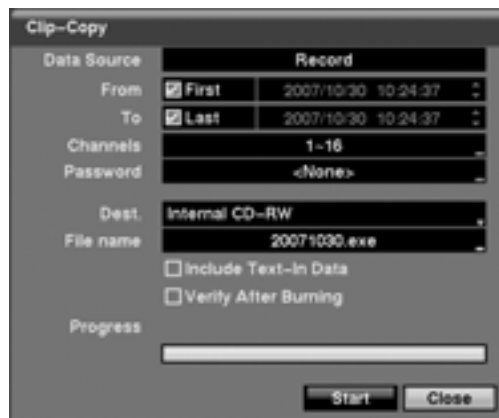

5. The **Data Source** box displays the source from which you make a video clip copy. The data source can be selected from **Record** or **Archive** in the Search menu.

6. You can search video from the first to last recorded images, or you can set the start and stop times and dates:
  - Highlight the box beside **From** and press **←** to toggle between On and Off. When set to **Off**, you can enter a specific Date and Time. When set to **On**, the search will be from the first recorded image.
  - Highlight the box beside **To** and press **←** to toggle between On and Off. When set to **Off**, you can enter a specific Date and Time. When set to **On**, the search will be from the last recorded image.
7. Highlight the box beside **Channels** and press **←**. You can select the cameras that you would like to include in your video clip.
8. Highlight the box beside **Password** and press **←**. A virtual keyboard appears allowing you to enter a password for reviewing the video clips.
9. Highlight the box beside **Dest.** and press **←**. You can select the storage device on which you would like to record the video clip. You can choose from **Internal CD-RW**, **Internal DVD-RW**, **USB Storage** and **USB CD-RW**.

---

**Caution** The USB device for clip copy must be FAT16 or FAT32 format.

---

---

**Note** While copying video clips to the CD-RW or DVD-RW, the recording speed might decrease.

---

---

**Note** While copying video clips to the CD-RW or DVD-RW, the DVR will stop archiving video data until clip copying is finished.

---

---

**Note** When the error message Firmware update of the optical drive is required displays, update the firmware of the installed CD-RW drive or DVD-RW drive. Please follow the instructions described in *System Information, page 39*.

---

10. The DVR automatically assigns a file name to the video clip. However, you can give the video clip file a different name. Highlight the box beside **File Name** and press **←**. A virtual keyboard appears. Enter a file name for the video you are backing up and select **Close**. The DVR will automatically add the camera number (for example, 01) and **.exe** to the file name. If you want to save the file in a specific folder, enter the folder name followed by a **"/**". For example: "folder/filename".

---

**Note** When naming a file, you cannot use the following characters: \, /, :, \*, ?, ", <, >, |.

---

11. Highlight **Include Text-In Data** and press **←**. This will toggle between On and Off. When this feature is On, you can include text-in data when copying video if the recorded video has text-in data.
12. Highlight **Verify After Burning** and press **←**. This will toggle between On and Off. When this feature is on, you can verify that the data is written on the CD-RW or DVD-RW properly.
13. Once you have given the video clip a file name, highlight **Start** and press **←**. The confirmation screen displaying data size will appear. When the storage device does not have enough space, the DVR will ask if you want to copy as much of the video clip as possible in the available space. Highlight **Continue** and press **←** to continue clip copy.
14. Once the clip copy starts, you can cancel it by selecting **Cancel** or hide the screen by selecting **Close**. When selecting **Close**, Clip Copy continues and a confirmation screen will display when it is complete.

---

**Note** Only 4.7GB DVD media is available. To clip copy video on the DVD media using remaining space, the size of previously recorded data on the DVD media should be less than 4GB.

---

---

**Note** The file size for clip copy is limited to 2GB.

---

15. You can use other functions on the DVR while video is being backed up. To do this, highlight **Close** and press **←**. You can return to the Clip-Copy screen at any time to check the progress.

Refer to *Appendix C, Reviewing Video Clips* for instructions on how to review video clips you have copied.

---

**Note** During Clip Copy, you cannot shut the system down, clear data on the storage device, or format the storage device.

---

---

**Caution** Do NOT disconnect the USB cable or the power from the external drive while copying video clips. If the external drive is shut down or the USB cable is disconnected while copying video clips, THE DVR SYSTEM MAY NOT WORK NORMALLY OR THE EXTERNAL DRIVE COULD BE DAMAGED, and you will get an error message the next time you try to copy video clips. You will need to power down the DVR and restart it to get rid of the error message. Once the file system of the USB-IDE hard disk drive has been corrupted, this error message cannot be dismissed. Even after restarting the DVR it may automatically restart while preparing to clip copy. You must recover the file system using the recovery program, or you must reformat the hard disk drive.

---

## Print Screen

You can print images from the screen. Connect a PostScript™ printer to one of the USB ports. A message appears asking you if you want to print the current image.

**Figure 4-21** Print Screen

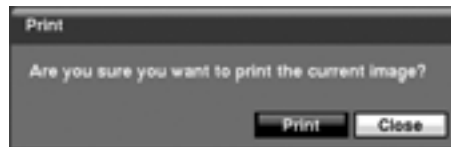

---

**Note** If your printer only supports an LPT connection (parallel), use an LPT to USB converter cable. The printer cable is not provided.

---



# A

## USB Hard Disk Drive Preparation

---

### Preparing the USB-IDE Hard Disk Drive in Windows 2000

---

---

**Note** Preparing a USB-IDE hard disk drive under Windows XP is almost identical to Windows 2000.

---

1. Connect the USB-IDE hard disk drive to your computer using the USB Cable.
2. Turn on your computer.
3. The USB device icon should display on the Taskbar.
4. If the USB-IDE hard disk drive is partitioned or has data, it will show up in **My Computer** as a hard disk drive icon. Check the file system by right-clicking on the icon and checking under **Properties > General > File System**. If the file system is NOT FAT32 format, format the USB-IDE hard disk drive using the FAT32 format.
5. If the USB-IDE hard disk drive is not partitioned, go to **Administrative Tools** in the **Control Panel** and launch **Computer Management**. Open **Disk Management in Storage** and right-click an unallocated region of the USB-IDE hard disk drive. Then, click **Create Partition**.
6. In the **Create Partition wizard**, click **Next** then **Primary Partition**, and follow the instructions on the screen. Make sure that the FAT32 is selected for the file system.

---

**Note** The partition size should be less than 32GB because of Microsoft limitations.

---

After formatting is complete, the USB-IDE hard disk drive will be added to **My Computer**.

7. Connect the USB-IDE hard disk drive to the DVR.

---

## Preparing the USB-IDE Hard Disk Drive in Windows 98

---

---

**Note** Preparing a USB-IDE hard disk drive under Windows ME is almost identical to Windows 98.

---

1. Connect the USB-IDE hard disk drive to your computer using the USB Cable.
2. Turn on your computer. The **Add New Hardware wizard** window will appear.
3. Install the device driver for the USB backup device following the instructions provided with your USB hard disk drive.
4. If the USB-IDE hard disk drive is partitioned or contains data, it will show up in **My Computer** as a hard disk drive icon. Check the file system in **Properties > General > File System**. If the file system is NOT FAT32 format, format the USB-IDE hard disk drive with FAT32 format.
5. Run the FDISK utility by clicking **Start** then **RUN**. Type **fdisk** and click **OK**.
6. When the MS-DOS command prompt appears, type **Y** and hit the enter key.
7. In the FDISK Option menu, choose **5. Change current fixed disk drive**.
8. Choose the appropriate letter corresponding to the USB-IDE hard disk drive.
9. In the FDISK Option menu, choose **1. Create DOS partition or Logical DOS Drive**.
10. In the Create DOS Partition or Logical DOS Drive menu, choose **1. Create Primary DOS Partition**. Type **Y** to use all available space and press the enter key. Press **ESC** to exit the screen after the USB-IDE hard disk drive partition is created.
11. Restart your computer and verify the newly created drive is in **My Computer**.
12. Right-click the newly created hard disk drive icon and select **Format**.
13. In the Format Screen, select **Full** as the **Format type** and click **Start**.
14. After formatting is complete, connect the USB-IDE hard disk drive to the DVR.

# B

## Text In Search Examples

---

### Search Example 1

---

1 2 3 4 5 6  
123456789012345678901234567890123456789012345678901234567890

Item	Unit price	Qty	amount
Coke	\$ 2.20	1(s)	\$ 2.20
Fanta	\$ 2.20	1(s)	\$ 2.20
Hotdog	\$ 3.50	3(s)	\$ 10.50
Pepsi	\$ 1.95	1(s)	\$ 1.95
total : \$			16.85

Thank you~~

In the above text-in data, you can find that the comparison value is located at 17<sup>th</sup> (Unit price, \$ mark will be ignored automatically), 28<sup>th</sup> (Qty) and 40<sup>th</sup> (amount) characters (including spaces) from the left. In this case, you can enter "17", "28" and "40" in each **Column** box.

For example, if you want to search for Coke with a **Qty** (Quantity) of more than 1 and Hotdog with an **amount** totaling over \$8, the following search condition can be set.

**Figure B-1 Text-In Search Option Example 1**



---

## Search Example 2

---

1	2	3	4	5	6
1234567890123456789012345678901234567890123456789012345678901234567890					
Item	Unit price	Qty	amount		
=====					
Coke	\$ 2.20	1(s)		\$ 2.20	
Fanta	\$ 2.20	1(s)		\$ 2.20	
Hotdog	\$ 3.50	3(s)		\$ 10.50	
Pepsi	\$ 1.95	1(s)		\$ 1.95	
=====					
			total : \$	16.85	

Thank you~~

In the above text-in data, you can find that the comparison value is located at 17<sup>th</sup> (Unit price, \$ mark will be ignored automatically), 28<sup>th</sup> (Qty) and 40<sup>th</sup> (amount) characters (including spaces) from the left, but the value of **amount** category is located on a different line from **Item**. In this case, you can enter “17”, “28” and “40” in each **Column** box and enter “1” in the **Line** box for the next line.

For example, if you want to search for Coke with a **Qty** (Quantity) of more than 1 and Hotdog with an amount totaling over \$8, the following search condition can be set.

Figure B-2 Text-In Search Option Example 2





# C

## Reviewing Video Clips

You do not need to install any special software on your personal computer to review the video clips. The copied video clip contains the Clip Player program.

1. If you used a USB device, disconnect either the external USB-IDE hard disk drive or USB flash drive from the DVR, and connect it to your PC. If you used a recordable CD, insert the CD in your computer's CD drive.
2. Double-clicking the target clip file starts the Clip Player program.

---

**Note** It is suggested that the computer used for the Clip Player program has at least an 800MHz Pentium III. If your CPU is slower than this, video clips recorded at maximum speed with very high image quality will be played back slowly. Also DirectX 8.0 or higher is required to run Clip Player, and a VGA card with 16MB or more video RAM is recommended for proper operation.

---

**Figure C-1** Clip Player Screen















3. The **Clip Player Screen** displays the clip images. Use the player controls to review the clip.

---

**Note**

Proper image display depends on the display settings of your PC. If you are experiencing display problems, click the right mouse button on the background screen and select **Properties > Settings** then set the **Color quality** to **32 bit**. Then select **Advanced > Troubleshoot** and set **Hardware Acceleration** to **Full**. Please make sure that DirectX version 8.0 or higher has been installed if the display problem continues to occur. To check the version of DirectX, click **Start > RUN** and type **dxdiag** and press the enter key. The DirectX Diagnostic Tool dialog box will display. Then move to the **Display** tab and make sure **DirectDraw Acceleration** is set to **Enabled**. Test the DirectDraw by selecting the **DirectDraw Test** button. After changing the settings, update the driver version of the VGA card. If you still have display problems after changing all display settings as described above, try replacing the video card. Video cards with an ATI chipset are recommended.

---

- Clicking  exits the Player program.
- Click  to go to the beginning of the video clip.
- Click  to play the video clip in fast reverse.
- Click  to go back one frame of the video clip.
- Click  to play the video clip.
- Click  to go forward one frame of the video clip.
- Click  to play the video clip in fast forward.
- Click  to go to the end of the video clip.
- Click  to show the previous page.
- Click  to cycle through the screen layouts (2x2, 3x3 and 4x4).
- Click  to show the next page.
- Click  to select from **Save**, **Print**, **Info**, **Image Processing**, **Video Format** and **Show Text In**. Selecting **Save** saves the current image in a bitmap file format on the local hard disk drive or floppy disk. Selecting **Print** lets you print the current image on the printer connected to your computer. Selecting **Info** displays Channel, Title, Time, Type, Size and Resolution information about the image. Selecting **Image Processing** allows you to control brightness, blur and sharpen for playback images. Selecting **Video Format** allows you to find appropriate display environments that can be varied depending on the type of graphics card installed in your PC. Use **Video Format** option when you are experiencing improper image display. Selecting **Show Text In** displays video with text-in data if the video has been recorded with text-in data.



---





**Note** **Image Processing** works only in the single-screen layout and in pause mode.

---

---

**Note** If you are not sure about the appropriate **Video Format** option, try each option until the image displays properly.

---

- Click  to select from **Normal** and **Double** screen views. Clicking the left mouse button on the enlarged image moves its position.
- Click  to display the image full screen.
- Encryption icons display in the bottom-right corner.  indicates the clip file has not been tampered with, and  indicates the system has detected tampering.

---

**Note** If the VGA card or monitor for your PC does not support 640x480 video resolution, **Full Screen** might not display properly when selected. If this happens, press **ESC** on your PC to return to the normal screen mode.

---

- Click the slider bar and move it left or right to move through the video clip.
- Placing the mouse cursor on an image and clicking it will cause that image to display full frame.

## Reviewing Video Clips

# D

## WebGuard

WebGuard allows you to access a remote DVR, monitor live video images and search recorded video using Internet Explorer web browser anytime from virtually anywhere.

Computer system requirements for using the WebGuard program are:

- Operating System: Microsoft® Windows® 2000, Microsoft Windows XP or Microsoft Windows Vista
- CPU: Intel Pentium III (Celeron) 600MHz or faster
- RAM: 128MB or higher
- VGA: 8MB or higher (1024 x 768, 24bpp or higher)
- Internet Explorer: Version 6.0 or later

1. Start Internet Explorer on your local PC. You can run the WebGuard program by entering the following information in the address field:

**Http://IP address:port number.** The DVR IP address and the WebGuard port number set in the Network setup screen (WebGuard tab).

OR

**Http://DVRNS server address/DVR name.** The DVRNS server address and the DVR name registered on the DVRNS server.

---

**Note** You will need to get the appropriate IP address for the DVR you want to connect to and the WebGuard port number from your network administrator.

---

---

**Note** WebGuard only works with Microsoft Internet Explorer and will NOT work with Netscape.

---

---

**Note** When running WebGuard in the Microsoft Windows Vista operating system, it is recommended to start Internet Explorer with elevated administrator permissions. Click the right mouse button on the Internet Explorer icon and select the **Run as administrator** option from the context menu. Otherwise, some functions of WebGuard might be limited to use.

---

**Figure D-1 WebGuard Login Screen**



2. Select between the **WATCH** (Web monitoring) and **SEARCH** (Web search) modes and enter the appropriate port number of the program.
3. Entering **ID** and **PASSWORD** and clicking the **[LOGIN]** button logs in using the selected mode.
4. Selecting **Save ID** saves the ID you entered.

---

**Note** The port numbers for **WATCH** and **SEARCH** should be the same as the port numbers for **Remote Watch** and **Remote Search** set during Network setup.

---

---

**Note** When running the updated WebGuard for the first time, Internet Explorer might occasionally load the information of the previous version. In this case, delete the temporary internet files by selecting **Tools > Internet Options > General** tab, and then run WebGuard again.

---

---



## Web Monitoring Mode

---

WebWatch is a remote web monitoring program that allows you to monitor live video transmitted in real-time from the remote DVR.

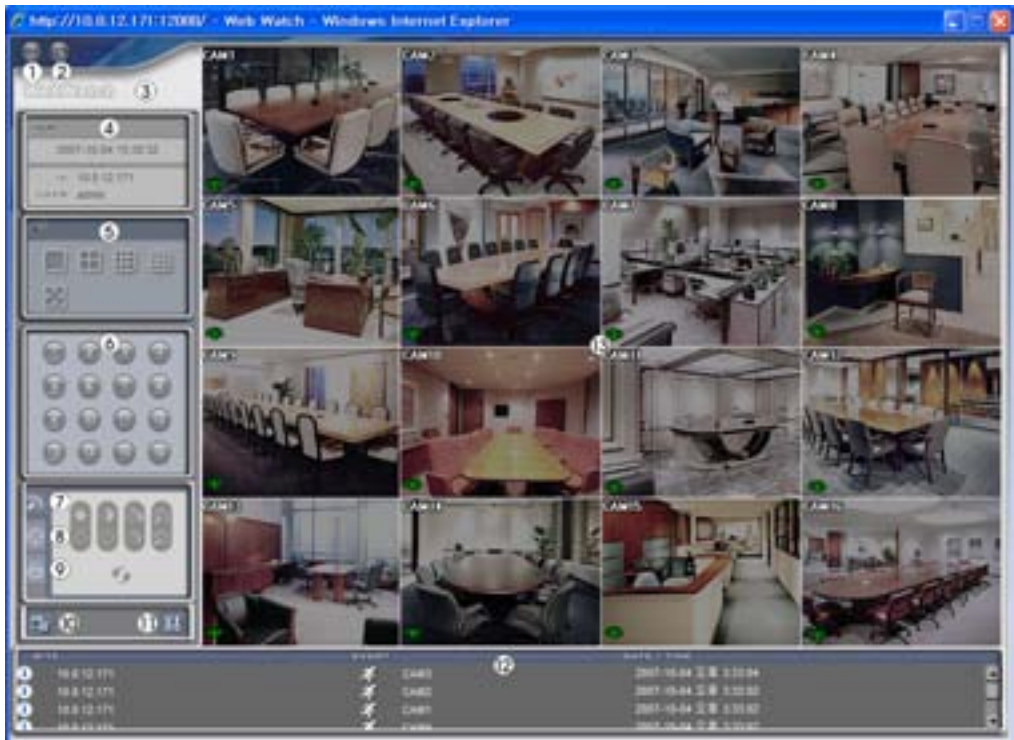
**Figure D-2 WebGuard Screen**



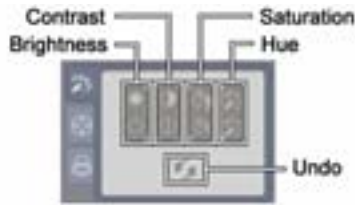

1. Click  to log out of the WebGuard program.
2. Click  to access the web search mode.
3. Position the mouse pointer on the **WebWatch** logo to see the version of the WebGuard program.
4. The DVR information window displays the login information of WebGuard.
5. Click the screen format to select the desired display mode. When changing the screen format, and selected camera on the current screen will be located in the first cell of the new layout.
6. Click the camera button (1 to 16) to select the camera to be viewed.

- Click  to adjust the brightness, contrast, saturation and hue of the monitoring image.



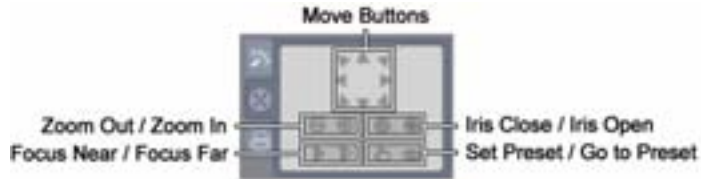

- Click  to control pan, tilt, and zoom of a PTZ camera from a remote site.

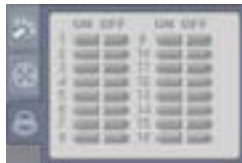

- Click  to control alarm out devices at the remote site.



- Click  to save the current image as a bitmap or JPEG file format.
- Click  to set up the image drawing mode and OSD display. You can adjust the display speed by changing the image drawing mode, and select the OSD information to display on the screen.
- The event status window at the bottom displays a list of events that were detected from the remote site.
- Selecting a camera on the screen and clicking the right mouse button displays the text menu screen.



- **Change Camera Title:** Changes the camera name.
- **Aspect Ratio:** Changes the image aspect ratio.
- **Anti-Aliasing Screen:** Enhances image display quality by eliminating stair stepping (aliasing) effects in the enlarged image.

---

**Note** The camera name changed in the Web Watch mode does not affect name set up on the remote site. Leaving the Camera Title blank causes the camera name set up on the remote site to display.

---

---

## Web Search Mode

---

WebSearch is a remote web search program that allows you to search recorded video on the remote DVR.



---

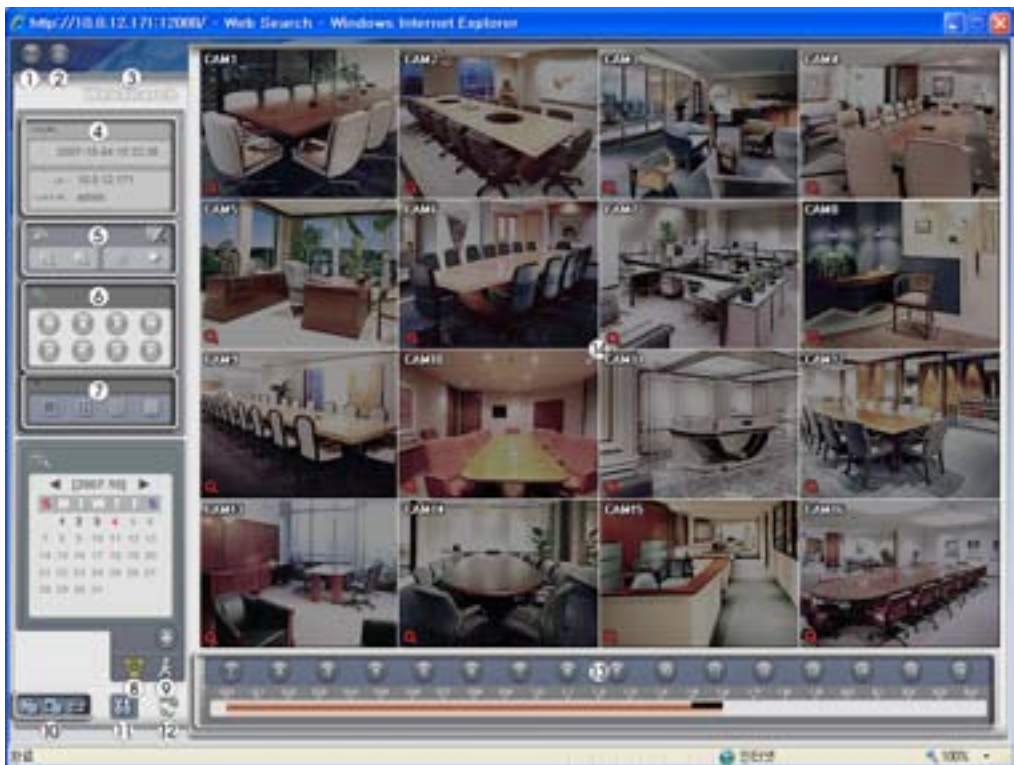

**Note** The remote site connection in the Web Search mode will automatically be disconnected if there is no activity for 30 minutes.

---

**Figure D-3 WebSearch Screen**



1. Click  to log out of the WebGuard program.
2. Click  to access to the web monitoring mode.
3. Position the mouse pointer on the **WebSearch** logo to see the version of the WebGuard program.
4. The DVR information window displays the time information of recorded data on the remote DVR and login information of WebGuard.



5. Click  to blur, sharpen, equalize and interpolate playback images. Click  to zoom out or zoom in on the recorded image. Click  to adjust the brightness of the recorded images.









---

**Note** Image processing works only in the pause mode.

---

6. The playback function buttons include fast backward, pause, play, fast forward, go to the first image, go to the previous image, go to the next image, and go to the last image.
7. Click the screen format to select the desired display mode.
8. Click  to enter the time-lapse search mode which allows you to search for recorded data by time and then play back images found within the time parameters. The Timetable window located at the bottom displays the time information for the image of the date selected on the calendar. If more than one video stream is in the same time range, you can select the video stream you want to search. Clicking a specific time displays the image recorded at that time on the screen. Selecting  allows you to display an image from a specific time.



9. Click  to enter the event search mode which allows you to search for event log entries using specific conditions and play back the images associated with those event entries.
10. Click  to save any video clip of recorded data as an executable file, or click  to save the current image in a bitmap or JPEG file format. Click  to print the current image on a printer connected to your computer.
11. Click  to set up the image drawing mode and OSD display. You can adjust the display speed by changing the image drawing mode, and select the OSD information to display on the screen.
12. Click  to reload the recording data.
13. The timetable displays recorded data of the selected camera by time (in hour segments).



14. Selecting a camera on the screen and clicking the right mouse button displays the text menu screen.



- **Change Camera Title:** Changes the camera name.
- **Aspect Ratio:** Changes the image aspect ratio.
- **Anti-Aliasing Screen:** Enhances image display quality by eliminating stair stepping (aliasing) effects in the enlarged image.

---

**Note** The camera name changed in the Web Search mode does not affect the camera name set up on the remote site. Leaving the Camera Title blank causes the camera name set up on the remote site to display.

---



# E

## Time Overlap

If the DVR's time and date have been reset to a time that is earlier than the existing recorded video, it is possible for the DVR to have more than one video stream in the same time range. In this case, you can search overlapping video streams individually by selecting a specific segment. For example, when the DVR has recorded video from one to five o'clock and the user changes the time backward from five to three o'clock and then continues recording until six o'clock, there will be two video streams and segments from three to five o'clock.

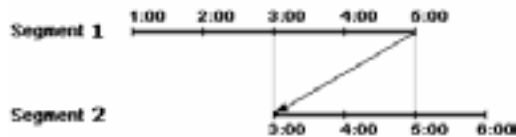

You can search overlapping video streams by selecting a specific time or time range. If you want to search recorded video at four o'clock during the overlapping time range using a search menu such as **Go to the Date/Time**, select the segment you want to search.

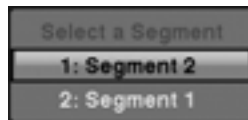

If you want to search recorded video from four to five o'clock during the overlapping time range using a search menu such as **Event Log Search**, **Text-In Search** or **Motion Search**, it is possible for the DVR to have two overlapping start and stop times. You will be asked to select one of the overlapping start and stop times from the search time ranges as follows:

- From four o'clock of the first segment to five o'clock of the first segment
- From four o'clock of the first segment to five o'clock of the second segment
- From four o'clock of the second segment to five o'clock of the second segment

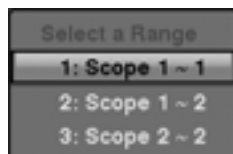







# F

## Troubleshooting

**Table F-1 Troubleshooting**

<b>Problem</b>	<b>Possible Solution</b>
No Power	<ul style="list-style-type: none"> <li>• Check power cord connections.</li> <li>• Confirm that there is power at the outlet.</li> </ul>
No Live Video	<ul style="list-style-type: none"> <li>• Check camera video cable and connections.</li> <li>• Check monitor video cable and connections.</li> <li>• Confirm that the camera has power.</li> <li>• Check camera lens settings.</li> </ul>
Live Video very bright	If a cable is attached to the Loop connector, make certain it is connected to a properly terminated device.
DVR has stopped recording	If the hard disk drive is full, you will either need to delete video or set the DVR to Recycle Mode.
The  icon displays, however, the DVR is not recording	When the DVR is in the Pre-Event recording mode, the yellow  and  display when there is no event, and the DVR is not recording. The red  and  display when any event occurs and the DVR starts recording.



# G

## Connector Pin Outs

### I/O Connector Pin Outs

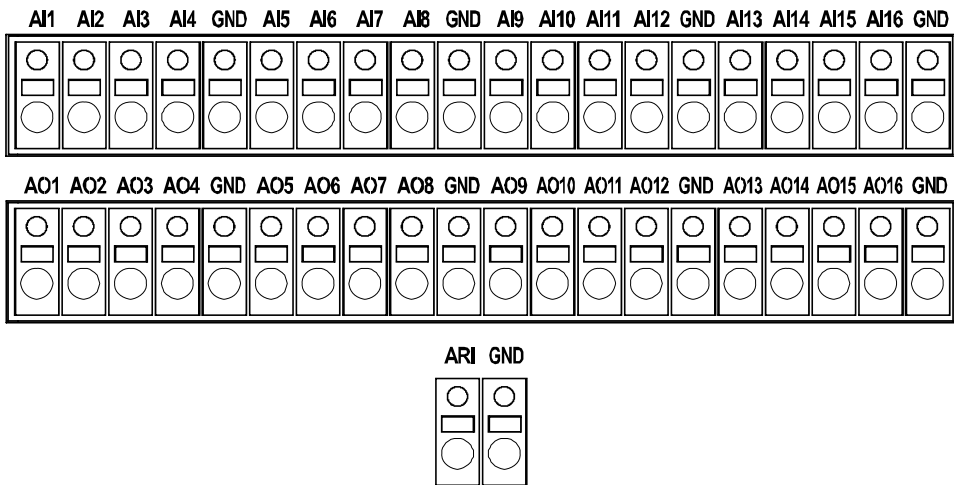

AI (1 to 16)	Alarm Inputs 1 to 16
GND	Chassis Ground (9 connectors)
AO (1 to 16)	Alarm Outputs 1 to 16
ARI	Alarm Reset In

---

## RS485 Connector Pin Outs

---

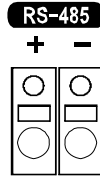

Master Unit	Slave Unit
+ ➡ To	➡ TX+
- ➡ To	➡ TX-
+ ➡ To	➡ RX+
- ➡ To	➡ RX-



## Map of Screens

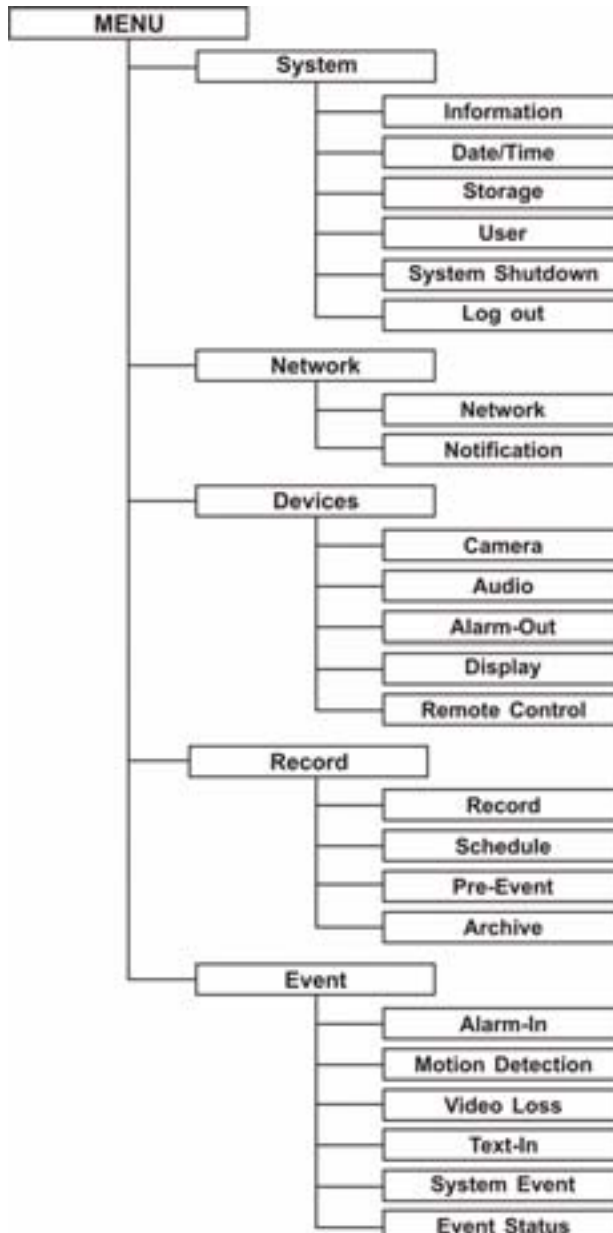

## Map of Screens



## System Log Notices

Boot Up	Schedule On
Shutdown	Schedule Off
Restart	Panic On
Upgrade	Panic Off
Upgrade Fail	Clear All Data
Power Failure	Clear Disk
Time Change	Format Disk
Time Zone Change	Disk Full
Time Sync	Auto Deletion
Time Sync Fail	Search Begin
Disk Bad	Search End
Login	Clip-Copy Begin
Logout	Clip-Copy End
Setup Begin	Clip-Copy Cancel
Setup End	Clip-Copy Fail
Remote Setup Change	Callback Fail
Remote Setup Fail	Print Begin
Setup Imported	Print End
Setup Import Failure	Print Cancel
Setup Exported	Archive On
Setup Export Failure	Archive Off
Setup Export Cancel	



## J

## Error Code Notices

<b>System Upgrade Related</b>	
<b>Number</b>	<b>Description</b>
0	Unknown error
1	File version error
2	Operating system version error
3	Software version error
4	Kernel version error
100	Upgrade device mounting failed
101	Package is not found
102	Extracting package failed
103	LILO failed
104	Rebooting failed
105	Invalid package
106	ODD firmware upgrade failed
300	Remote connection failed
301	Remote network error
302	Remote upgrade is not authorized
303	Saving remote package failed
304	Remote upgrade is cancelled by the user
400	USB device mounting failed
401	Reading upgrade package on the USB device failed
402	Copying upgrade package on the USB device failed
500	System is busy clip copying

---

**Clip Copy Related**

---

<b>Number</b>	<b>Description</b>
0	Unknown error
1	Device error
2	Mounting failed
3	No media
4	Invalid media
5	File already existed
6	Not enough space
7	Creating temporary file failed
8	Opening disk failed
9	Formatting disk failed
10	Database has been changed
11	Appending failed
12	Bad sector
13	No executable file
14	Opening executable file failed
15	Writing executable file failed
16	Creating image failed
17	Burning failed
18	Burning is out of time
22	Verify failed

---

# Specifications

---

**Note** Specifications are subject to change without notice.

---



---

## Video

Signal Format	NTSC or PAL (Auto Detect)
Video Input	Composite: 9 or 16 looping inputs, 1 Vp-p, auto-terminating, 75 Ohms
Monitor Outputs	Composite: 1 BNC, 1 Vp-p, 75 Ohms SVHS: 1 SPOT: 4 BNC, 1 Vp-p, 75 Ohms VGA: 1 <ul style="list-style-type: none"> <li>• NTSC: 30.8 kHz (horizontal frequency) / 60 Hz (vertical frequency)</li> <li>• PAL: 30.8 kHz (horizontal frequency) / 50 Hz (vertical frequency)</li> </ul>
Video Resolution	720 x 480 (NTSC), 720 x 576 (PAL)
Playback / Record Speed (images per second)	240 ips (NTSC), 200 ips (PAL)

---

## Inputs / Outputs

Alarm Input	9 or 16 TTL, programmable as NC or NO
Alarm Output	9 or 16 TTL open collector, 5mA @ 12V, 30mA @ 5V
Alarm Reset Input	1 TTL
Internal Buzzer	80 dB at 10 cm
Network Connectivity	10/100 Mbps Ethernet (RJ-45) RS232C for external modem

## Specifications

---

### Inputs / Outputs

---

Audio Input	RCA Input: 4 Line In
Audio Output	RCA Output: 1, Line Out
IR Port	1 Remote Control

---

---

### Connectors

---

Video Input	Composite: 9 or 16 BNC
Video Loop	Composite: 9 or 16 BNC (Auto Terminating)
Monitor Output	Composite: 1 BNC SVHS: 1 Y/C* VGA: 1 VGA SPOT (Composite): 4 BNC
Audio In	4 RCA connector
Audio Out	1 RCA connector
Alarm Input/Output	16/16 Push-button, Terminal Blocks
Ethernet Port	RJ-45
RS232C Serial Port	DB9 (P)
RS485 Serial Port	Two-connector terminal block
Ultra Wide SCSI Port	High density female 68-pin connector
USB Port	3 (USB 2.0)

---

\* Using a shielded S-Video cable provides better quality video display and reduces image noise.

---

### Storage

---

Primary Storage	EIDE hard disk drive (up to 2)
Secondary Storage**	Ultra Wide SCSI hard disk drive (RAID) Built-in CD-RW or DVD-RW drive USB hard disk drive, CD-RW drive or flash drive

---

\*\* When installing an internal CD-RW drive or DVD-RW drive, set the jumper to Master and connect to the Secondary IDE channel.



## Specifications

---

### General

---

Dimensions (W x H x D)	16.9" x 3.5" x 15.9" (430 mm x 88 mm x 405 mm)
Unit Weight	16.3 lbs. (7.4 kg)
Shipping Weight	23.6 lbs. (10.7 kg)
Shipping Dimensions (W x H x D)	21.3" x 11.4" x 23.2" (540 mm x 290 mm x 590 mm)
Operating Temperature	41°F to 104°F (5°C to 40°C)
Operating Humidity	0% to 90%
Power	100 to 240 VAC, 2 A, 60/50 Hz
Power Consumption	Max. 85 W (100 W when 4 hard disk drives are installed)
Approvals	FCC, UL,  CB, CE

---

---

**Note** Specifications are subject to change without notice.

---

## Specifications



# **Honeywell**

**[www.honeywellvideo.com](http://www.honeywellvideo.com)  
+ 1.800.796.CCTV (North America only)  
[HVSsupport@honeywell.com](mailto:HVSsupport@honeywell.com)**

Document 900.0856 – Rev B – 02/08

© 2008 Honeywell International Inc. All rights reserved. No part of this publication may be reproduced by any means without written permission from Honeywell Video Systems. The information in this publication is believed to be accurate in all respects. However, Honeywell Video Systems cannot assume responsibility for any consequences resulting from the use thereof. The information contained herein is subject to change without notice. Revisions or new editions to this publication may be issued to incorporate such changes.